CONTENT

Chapter 1 Control system function	2
1.1 Base function.....	2
1.2 Special function.....	4
1.3 Safety protective functions.....	6
1.4 Optional functions	6
Chapter 2 Component and installation of control system	7
2.1 Component of control system	7
2.1.1 Flow figure and principle of system.....	7
2.1.2 Component of control panel	7
2.1.3 Definition of input and output terminal	10
2.2 Installation of control system	14
2.2.1 Installation of hoistway and travelling cables	14
2.2.2 Installation and wiring of control panel	14
2.2.3 Installation of hoistway switch, and signal steel panel.....	15
Chapter 3 Operation and Parameter Definition of Hand Operator's LCD Interface	17
3.1 Summary.....	17
3.2 Operation guide of keyboard	17
3.3 Operation flow and parameter explanation	18
3.3.1 Main menu	19
3.3.2 Password Checking.....	19
3.3.3 Monitor menu and parameter setup flowchart.....	20
3.3.4 Parameter instruction	23
3.3.5 Save parameter	25
3.3.6 Set password	25
3.4 Window operation.....	26
3.4.1 Monitor menu	26
3.4.2 General parameter operation.....	30
3.4.3 Running parameter operation	36
3.4.4 Special parameter operation	39
Appendix 1 Figure of time-speed	45
Appendix 2 YASKAWA G7A Inverter Experienced Parameter Setting Table	47
Appendix 3: System Troubleshooting	49
Appendix 4: Troubleshooting while Hoistway Learning.....	51

Chapter 1 Control System Functions

1.1 Base Functions

No.	Name	Purpose	Explanation	Remark
1	Automation Running (no attendant)		<ol style="list-style-type: none"> 1). Opens the door automatically after landing; 2). Closes the door automatically after time delay; 3). Closed the door by hand previously (after the door fully opening but before the time delay); 4). Registers the car call automatically; 5). Lands automatically if there is same directional landing call; 6). Lands automatically toward the highest (or lowest) reverse directional landing call 	<ol style="list-style-type: none"> 1). Turn all the “normal/inspection” switch (car top, COP and control panel) to “normal” position; 2). Turn the “automation/attendant” switch to “automation” position.
2	Attendant Running		<ol style="list-style-type: none"> 1). Opens the door automatically after landing; 2). Closed the door by attendant’s hand; 3). Registers the car call automatically; if there is landing call, the relative car call button will flash; 4). Lands automatically if there is same directional landing call. 	<ol style="list-style-type: none"> 1). Turn all the “normal/inspection” switch (car top, COP and control panel) to “normal” position; 2). Turn the “automation/attendant” switch to “attendant” position.
3	Inspection Running	For commissioning, maintenance	When the system is in inspection mode, if keep pressing “up” or “down” push button, the elevator will move up or down with inspection speed, and stop once release.	The “normal/inspection” switches are separately located on car top, car and control panel which their priority is car top>car>control panel, for example, if car top “inspection” switch is on, it is impossible to move the elevator by pressing the “up” or “down” button in COP and control panel
4	Opens the door automatically once it’s powered on	Opens the door automatically	On the “automation” mode, if the car is at door zone, the the door will automatically open once the elevator is powered on.	This function is performed only on “automation” mode.

No.	Name	Purpose	Explanation	Remark
5	Delay time setting for automatical closing door (time of keeping door open)	Keeping door open	After the door completely opening, it keeps opening and closes the door automatically after delay time.	1). Delay time can be set as a parameter (T); 2). If it only stops for landing call, the delay time should be T-2 seconds; 3). If it only stops for both of car call and landing call, the delay time should be 2T seconds.
6	Door open for local zone landing call	Door open for landing call	The elevator door is closing or already closed but it does not start, if there is landing call of local zone (this call is the same direction with the pre-confirmed direction), then the door will reopen.	The delay time is the same as its setting value; if the landing call is opposite with the pre-confirmed direction, then the door will not reopen unless the direction is changed.
7	Safety edge or light curtain protection	Safety for door closing	Touching the safety edge or obstructing the light curtain while the door is closing can stop closing at once and the door will reopen automatically.	Reclose the door after the safety edge or light curtain being recovered.
8	No closing door once over load	Wait for reducing weight	While over load, the elevator will not close the door, and will lighten the alarm LED and sound the buzzer, and will not start.	Recover to the normal state automatically once over load disappears.
9	By pass when full load	Directly lands to the nearest floor registered by car call	While full load, the elevator performs only as per car calls, not landing calls.	Recover to the normal state automatically once full load disappears.
10	By pass controlled by attendant	VIP running	While attendant running, if press the "by pass" button, the elevator performs only as per car calls, not landing calls.	
11	Display of running state	For commissioning and repair	Many information such as running state and direction, position been, door state, load situation and fault, etc, can be shown on the LCD of operator.	
12	Fireman running		While fireman switch is switched on, the elevator will enter fireman running. 1). Cancel all registered calls; 2). Return to ground floor; 3). Keep door opening; 4). Output a signal to fire control center; 5). If the elevator is running at opposite direction, it will land at the nearest floor, keep the door closed, return to ground floor and keep the door opening.	

No.	Name	Purpose	Explanation	Remark
13	Parking control	Stop running	<p>After switching off key switch, the elevator will enter parking state.</p> <p>1). If the elevtor is running and there are car calls registered, then it will not respond any landing call, and will serve the registered car calls, then return to the parking floor (the parking floor can be set)</p> <p>2). If there is not registered car call, it will return the parking floor directly.</p> <p>3). After parking the elevator will:</p> <p>a. no longer respond any call;</p> <p>b. close the door automatically 10 seconds later, and switch off the indication of COP and all indicators</p> <p>c. open the door again if you keep press the “open” button, but it will reclose again after 10 seconds.</p>	<p>1). If the elevator is in inspection mode while the key switch is switched off, the elevator will not return to the parking floor, other functions will be kept;</p> <p>2). During parking state, the CPU is still working, so once the key switch is switched on, the elevator will quit the parking state at once, and start normal running.</p>
14	Leveling a floor after fault	For rescuing passenger	<p>When the elevator breaks down and stops at the middle between two floors during normal running, the elevator will crawl to the middle floor’s direction, level and open the door.</p>	<p>Under the conditions of that the safety circuit and inverter are normal</p>

1.2 Special functions

No.	Name	Purpose	Explanation	Remark
-----	------	---------	-------------	--------

3	Repeat door closing		After outputting the door closing dictate, if the door interlock circuit is not switched on during the stipulated time, then the door reopens and closes again.	If it repeats 5 times and the door interlock circuit is still "off", then the elevator stops running, and shows the fault code on the LCD of operator.
4	Make car calls in machine room	For commissioning	Make car calls by pushing buttons on operator	
5	Homing floor setting	Wait at homing floor	Under automation mode, if there is neither car call nor landing call during the set time, the elevator return to the homing floor automatically.	There is only one homing floor in one elevator.
6	The character of indicator can be set at will	Change the character of one (or more) floor indicating	Set the indicating character of each floor by pushing the buttons on the operator (English character or number with symbol).	
7	Extend the delay time of closing door	Extend the time of keeping door opened		

	electronic noise at input port	influence of electronic noise automatically at input port which comes from hoistway wiring.	input signals and show the conclusion at LCD, which can direct the technician to arrange traveling cable, hoistway wiring and earthing as best as they can, try to eliminate the electronic noise caused the parallel connect between hoistway wiring, traveling cable and the input port of PCB, therefore avoid the trouble of wrong display, leveling failure and so on.	input port.
13	Multi-function input and output	Function setting of input and output ports	It can define the function of input and output ports at will	

1.3 Safety protective functions

No.	Name	Explanation
1	Safety circuit protection	The elevator will stop at once if the safety circuit is switched off.
2	Door interlock protection	The elevator will run only when the door interlock circuit is ok, if the door interlock circuit is switched off or unreliable while it's running, it will stop at once.
3		

Chapter 2 Component and installation of control system

2.1 Component of control system

2.1.1 Flow figure and principle of system

The system flow figure refers to figure 2-1. The control unit of system is 32 bit microprocessor BL-2000-BHT. This unit adopts parallel collective mode to collect the signals from COP, HOP, hoistway and safety circuit, and outputs relevant control signals to control the inverter, door operator, brake and so on, hence realizes the logic functions, troubleshooting, etc.

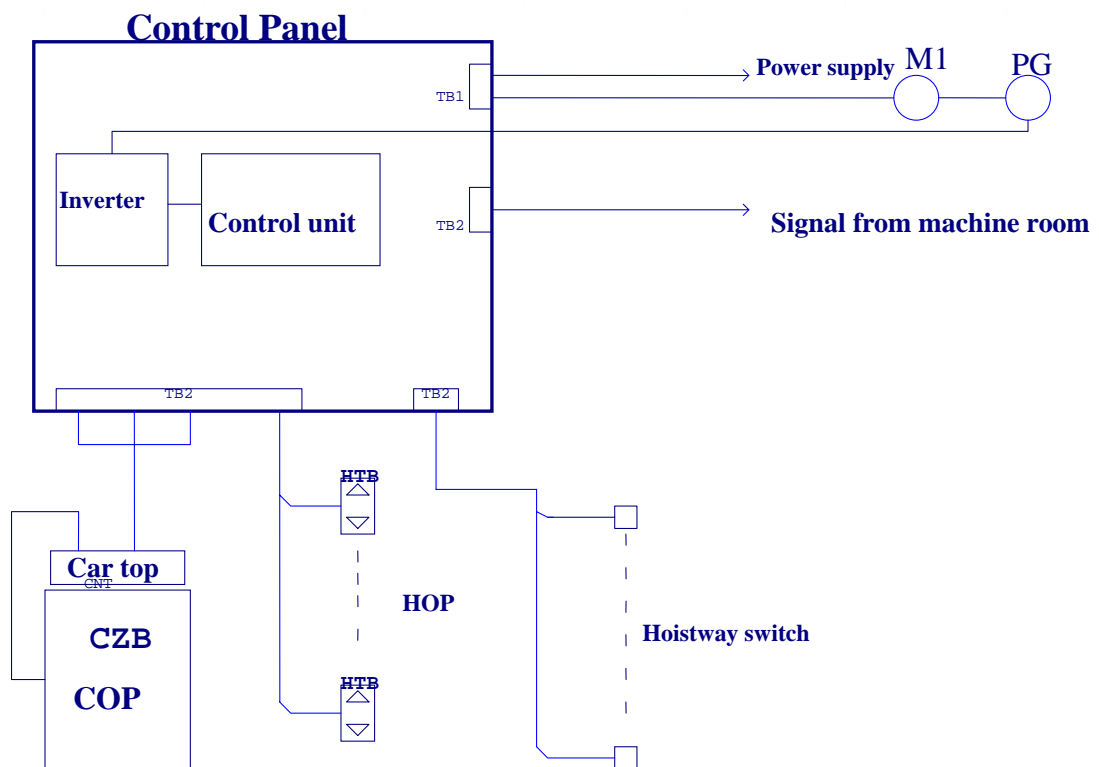

Figure 2-1 System flow figure

2.1.2 Component of control panel

The components layout figure 2-2 and the description of each component are as follows (just for reference):

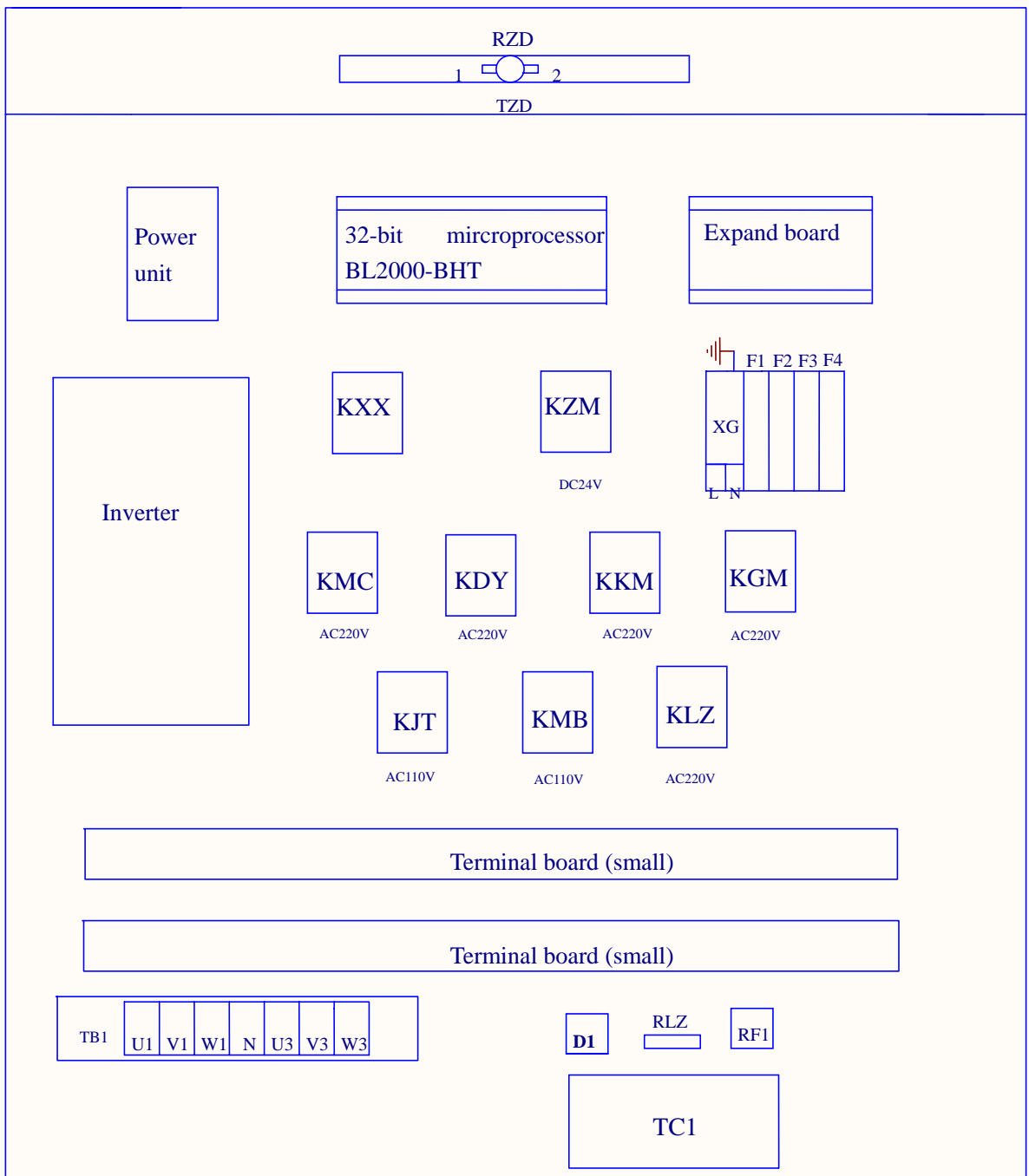

Figure 2-2 VVVF control panel components layout

Discription of components

- 1). Inverter: The drive unit of elevator, controlled by control unit.
- 2). TC1 Main control transformer. It provides power supply for whole system, its input is AC380V, and outputs are AC220V and AC110V two parts.
- 3). Power unit: The power supply for control unit, its input is AC220V, and outputs are DC24V and DC 5V two parts.
Warning: The powe unit shold be reliably earthed, otherwise it migh affect the control unit.
- 4). KXX Phase protective relay.
- 5). F1~F4 Breaker. F1: For main control power supply; F2: For 110V control power supply; F3: For 24V control power supply; F4: For 220V illumination power supply.
- 6). KMC: Main contactor. For the inverter power supply, once this contactor acts, the inverter gets the power supply.
- 7). KDY: Assistant contactor. The connection between inverter and motor, once this contactor acts, the motor gets connection to the inverter.
- 8). KJT: Safety contactor. It acts once the safety circuit is switched on.
- 9). KMB: Door interlock contactor. It acts once the door interlock circuit is switched on.
- 10). KLZ: Brake contactor. The brake opens once this contactor acts.
- 11). KKM: Door open contactor. The door operator works for opening door once this contactor acts.
- 12). KGM: Door close contactor. The door operator works for closing door once this contactor acts.
- 13). RZD: Brake resistance
- 14). TZD: Overheat protective switch. For monitor the temperature of brake resistance.
- 15). RF1: Rectifier. Output DC 110V
- 16). D1: Diode for brake discharging.
- 17). RLZ: Resistance for brake discharging.
- 18). KZM: Illumination relay. Once this relay acts, the illumination is switch off.
- 19). KXF: Fireman mode relay. The elevator will be I fireman only when this relay acts.(Optional)
- 20). Microprocessor control unit BL-2000-BHT

Microprocessor control unit is the center of the system, all control references are from this unit, and its layout is as follow:

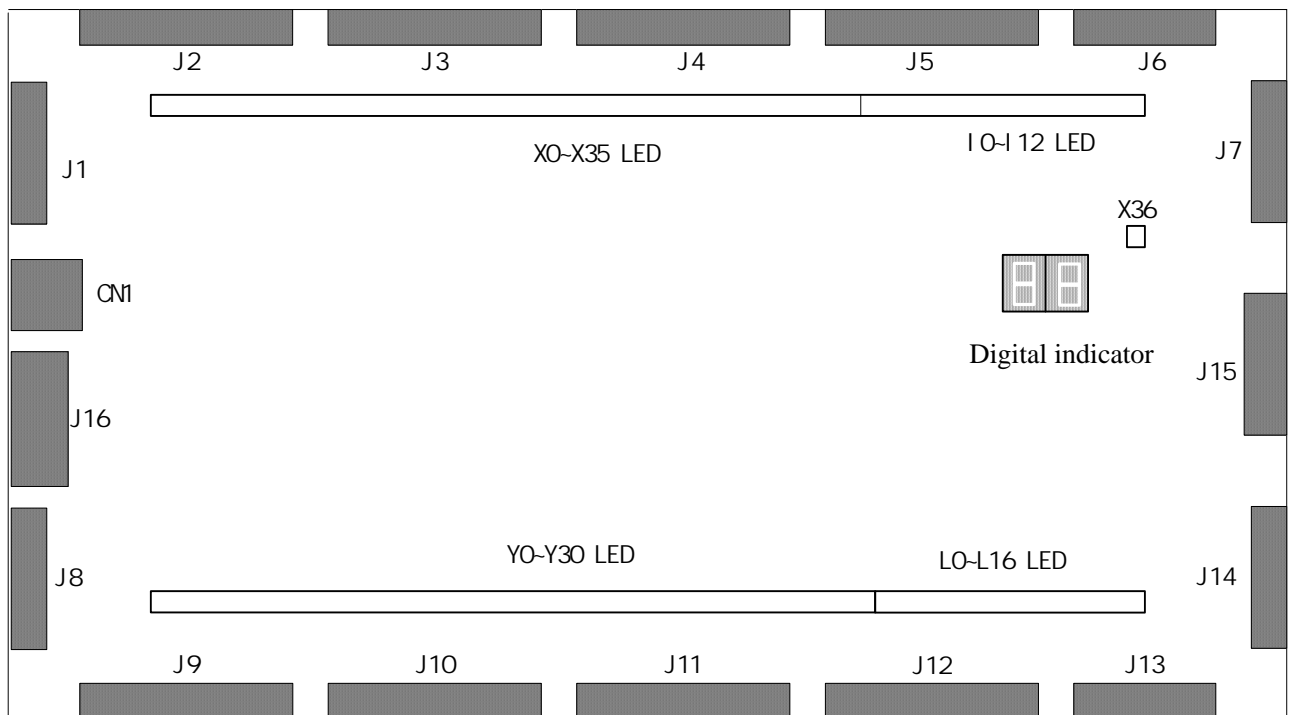

Figure 2-3 Layout of BL2000-BHT

Thereinto J15 is expandable port, CN1 is hand operator port, J16 is program port.

X0~X36 LED: Lightened if there is input signal from X0~X36.

I0~I12 LED: Lightened if there is input signal from I0~I12.

L0~L16 LED: Lightened if there is output signal from L0~L12.

Y0~Y30 LED: Lightened if there is output signal from Y0~Y30.

2.1.3 Definition of input and output terminal:

1). Input definition (48 I/O input + 1 COM + 3 encoder + 4 power supply)=56			
Terminal	Mark	Type	Definition
J1_1	12V	D	Encoder input power supply
J1_2	A+	D	Encoder A+
J1_3	A-(A)	D	Encoder A- or (A phase)
J1_4	B+	D	Encoder B+
J1_5	B-(B)	D	Encode B- or (B phase)
J2_1	X0	C	SJX: Inspection/Automation input
J2_2	X1	C	SSXW: Up limited switch input
J2_3	X2	C	SXXW; Down limited input
J2_4	X3	C	SSMQ: Up leveling switch input

J4_10	X29	C	SKYC: Door opened time extention input
J5_1	X30	C	SZH: Attendant signal input
J5_2	X31	C	SZS: By pass signal input
J5_3	X32	C	Brake inspection switch input
J5_4	X33	C	Overheat switch input
J5_5	X34	C	SKM2: Door open signal input 2 (for opposite door)
J5_6	X35	C	SGM2: Door close signal input 2 (for opposite door)
J5_7	I0	C	Car call 1
J5_8	I1	C	Car call 2
J5_9	I2	C	Car call 3
J5_10	I3	C	Car call 4
J6_1	I4	C	Car call 5
J6_2	I5	C	Landing call up 1
J6_3	I6	C	Landing call up 2
J6_4	I7	C	Landing call up 3
J6_5	I8	C	Landing call up 4
J7_1	I9	C	Landing call down 2
J7_2	I10	C	Landing call down 3
J7_3	I11	C	Landing call down 4
J7_4	I12	C	Landing call down 5
J7_5	X36+	B	Door interlock circuit + 110V—220VAC
J7_6	X36-	B	Door interlock circuit - 110V—220VAC
J7_7	24V2		24V Input
J7_8	5V		5V Input
J7_9	GND1		24V,5V Earthing
J7_10	24V1		COM of input (24V)

Input type
(electrical drawing)

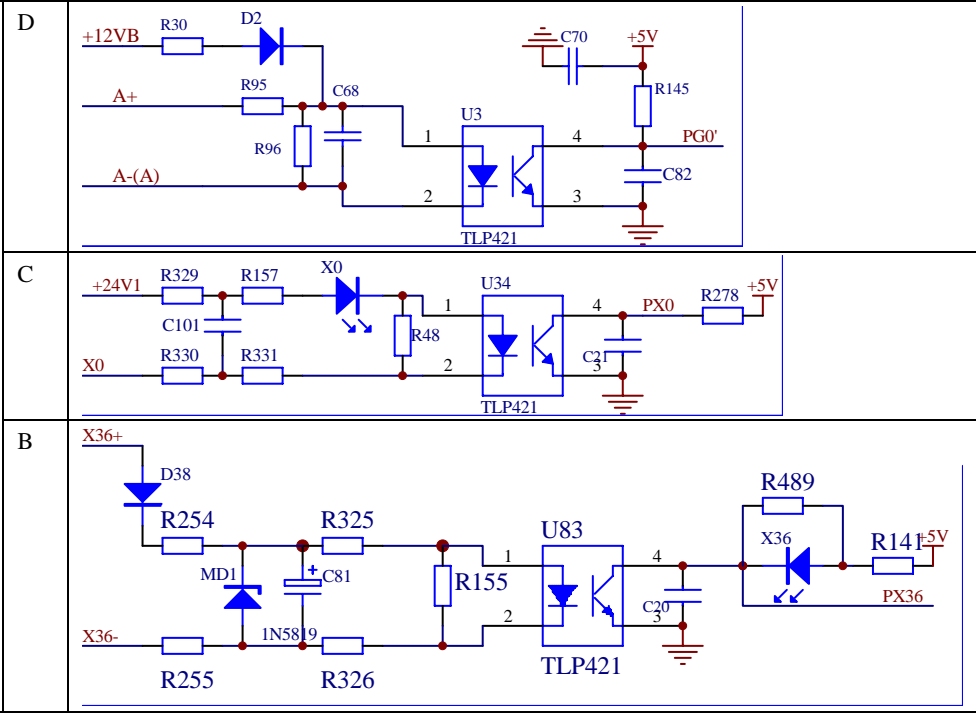

2). Output definition: (45 I/O output +10 COM)=55

Terminal	Mark	Type	Definiation
J8_1	Y0	E	KBC: Brake output
J8_2	Y1	E	KPC: Main contactor output
J8_3	Y2	E	KDY: Assistant contactor output
			COM of Y0-Y2
		E	KS: Up output
		E	KX: Down output
		E	JOG output

J12_7	L3	F	KYC: Door opened extension output
J12_8	L4	F	Car call reply output 1
J12_9	L5	F	Car call reply output 2
J12_10	L 6	F	Car call reply output 3
J13_1	L 7	F	Car call reply output 4
J13_2	L 8	F	Car call reply output 5
J13_3	L 9	F	Landing call up reply output 1
J13_4	L 10	F	Landing call up reply output 2
J13_5	L 11	F	Landing call up reply output 3
J14_1	L 12	F	Landing call up reply output 4
J14_2	L13	F	Landing call down reply output 2
J14_3	L14	F	Landing call down reply output 3
J14_4	L15	F	Landing call down reply output 4
J14_5	L16	F	Landing call down reply output 5
J14_6	CM8		COM of L0-L17

E

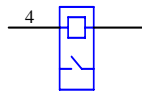

display of L1~L12 output signal (output relay).

The explanation of each part should be as follows:

J1 is extension input port, J2 is extension output port

J3 is input signal port for I1~I10. Max. 2 units (Extension I/Extension II)

Port No.	Position	Definition
I1	J3_1	SN6, Car call input 6/SN10, Car call input 10
I2	J3_2	SN7, Car call input 7/SN11, Car call input 11
I3	J3_3	SN8, Car call input 8/SN12, Car call input 12
I4	J3_4	SN9, Car call input 9/SN13, Car call input 13
I5	J3_5	SH5, landing call up 5/SH9, landing call up 9
I6	J3_6	SH6, landing call up 6/SH10, landing call up 10
I7	J3_7	SH7, landing call up 7/SH11, landing call up 11
I8	J3_8	SH8, landing call up 8/SH12, landing call up 12
I9	J3_9	XH6, landing call down 6/XH10, landing call down 10
I10	J3_10	XH7, landing call down 7/XH11, landing call down 11

J4 is input signal port for I11~I12. Max. 2 units (Extension I/Extension II)

Port No.	Position	Definition
I11	J4_1	XH8, landing call down 8/XH12, landing call down 12
I12	J4_2	XH9, landing call down 9/XH13, landing call down 13
	J4_3	No
	J4_4	No
	J4_5	No

2.2 Installation of control system

2.2.1 Installation of hoistway and travelling cables

Installation and wiring of the hoistway and travelling cables should according to the electrical drawing.

While welding is processed, the nature wire of welding machine must be connected reliably with the component which will be welded, it's strictly forbidden to make use of the cable's earth wire as the nature wire of welding machine, otherwise the cable will be burnt.

2.2.2 Installation and wiring of control panel

There are seven main circuit terminals in control panel, thereinto U1, V1, W1 are the 3 phase power supply input. The power supply which comes from main power switch is required to connect to terminal U1, V1, W1, nature to terminal N. The section of wire should be counted as per the total electric load of circuit, for one elevator with 15 KW or above motor, the section of wire should not be less than 10mm². Another 3 terminals U3,V3,W3 are required to be connected to the motor, it's strictly forbidden to mistake this two group terminals, **otherwise the inverter will be burnt once power supply is switched on.!** When you arrange the cables, wires in machine room, it's strictly required to separate control circuit from main circuit to keep the stability of the system. The wire length between control panel and motor should be shortest if possible to reduce the wastage of output power, if necessary, enlarge the section of wires.

2.2.3 Installation of hoistway switch, and signal steel panel

- 1). Door zone switch: Elevator needs 2 door zone switches and some signal steel panels to control leveling. 2 door zone

switches are fixed at car top; signal steel panels are fixed in hoistway, which position refers to the following figure2-5:

Door zone switch adopt photo electronic switch or magnistor.

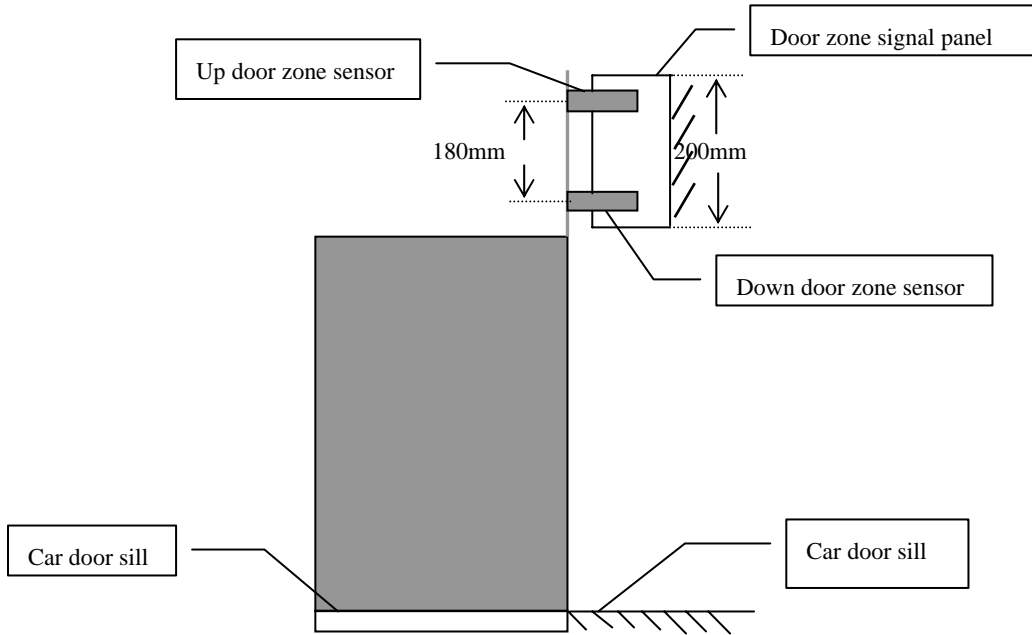

Figure 2-5 door zone switch and signal steel panels

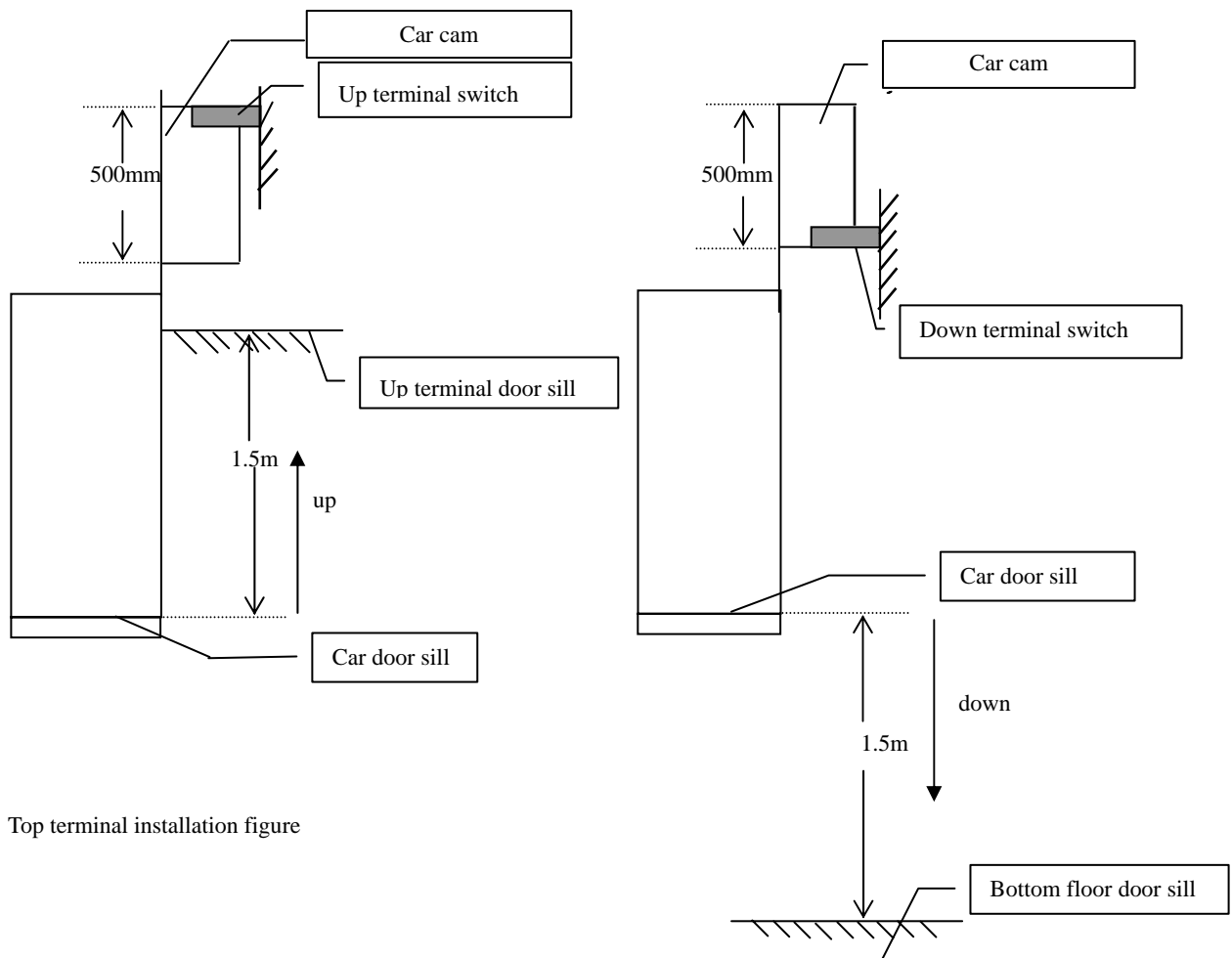

figure 2-6 up/down terminal installation figure 1.0m/s

2). Terminal switch: Elevator needs one up terminal switch, down terminal switch and car cam; up/down terminal switch are fixed in hoistway, and car cam is fixed on car frame, which position refers to the following figure2-6:



Chapter 3 Operation and Parameter Definition of Hand

Operator's LCD Interface

3.1 Summary

The hand operator's LCD indicator provides a good communication interface for technicians to observe the system and set the parameters. Details are as follows:

- 1). Monitor the state of elevator: automation, inspection, attendant, fireman, locking, etc;
- 2). Observation: I/O port, fault code, landing call, car call, etc;
- 3). Parameter setting: base parameter, running parameter, special parameter, etc;
- 4). Parameter saving;
- 5). New password setting.

Note: this operator is an optional part.

3.2 Operation guide of keyboard

Refer to the following figure, there are six keybuttons on operator, their layout and definition are as follows:

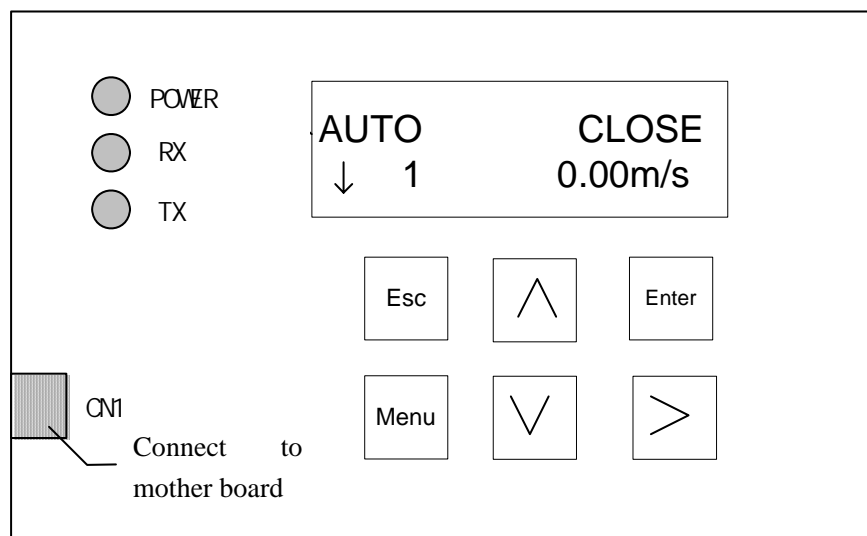

Keyboard definition:

“Menu” -- Return to the main interface in any case.

“Enter” -- Enter the submenu, confirmation keybutton for a parameter modifying and call registering.

“Esc” -- Return to the upper-menu, cancel an operation.

“>” -- Move the cursor (circle right moving).

“ ” -- Page up, plus 1 and choose “yes (on)” when parameter is set.

“ ” -- Page down, minus 1 and choose “no (off)” when parameter is set.

3.3 Operation flow and parameter explanation

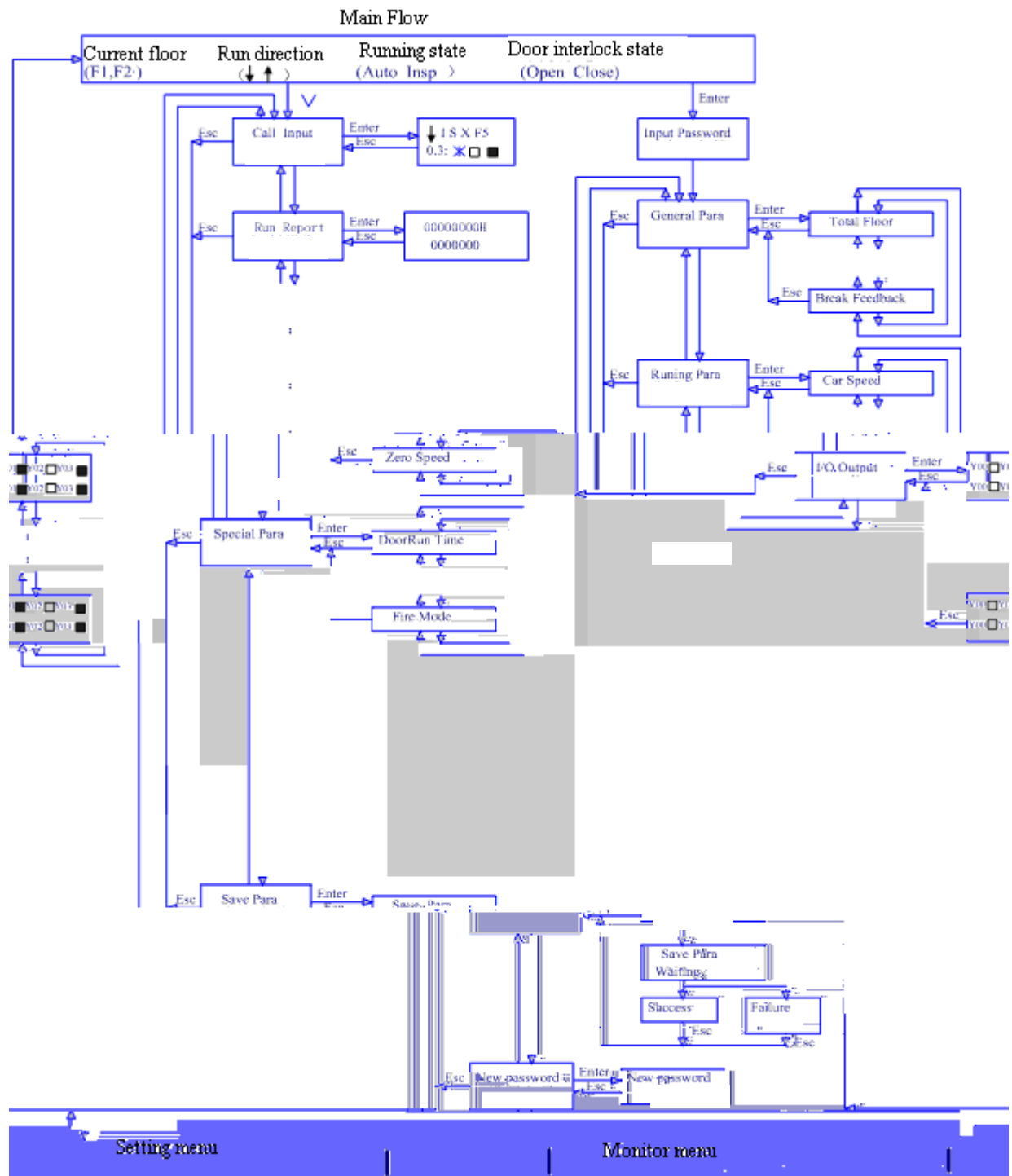

3.3.1 Main menu

It is back to this interface once “Menu” button is pressed in any case except hoistway self-learning being processed (shows “learning.....”) and parameter being saved (shows “waiting.....”).

It shows current floor, running direction, mode, fault code, door interlock state, running speed, etc.

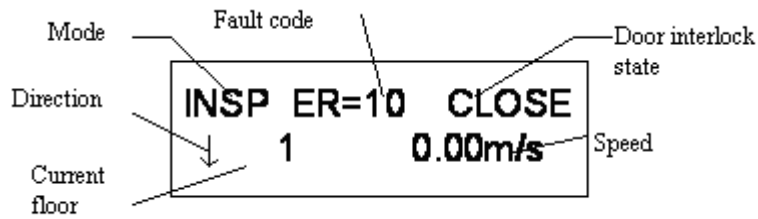

- Ø Mode: “INSP” - Inspection; “MANU” - Attendant; “AUTO” - Automation; “FIRE” - Fireman; “STOP” Key switch off; “USED” - Special for VIP.
- Ø Fault Code: It shows “ER=# (Fault code)” once there is fault, it’s empty if there is not fault.
- Ø Door interlock state: “CLOSE” - Door close; “OPEN” - Door open.
- Ø Current floor: The floor where elevator is at (Actual floor)

Definition of proper noun:

Actual floor - Floor number at indicator which can be set in menu;

Absolute floor - bottom floor is 1, the second floor is 2, the third floor is 3.....

3.3.2 Password Checking

When there is necessary to set and save parameters, the elevator should be in inspection mode, input the user class password to enter the user class setting menu, the details refer to 3.3.3(a); or input the factory class password to enter the factory class setting, the details refer to 3.3.3(b). The original user class password is “0000” and the original factory class password is “1010” which can be modified in “password setting” menu.

Steps:

- 1) In the “Main Menu” surface, press “Enter” key; if the current LCD surface is not the “Main Menu”, please press “Menu”key to return to the “Main Menu” then press “Enter” key.

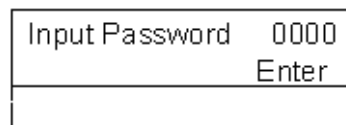

- 2) After entering to the “Password Enter” interface, press“ ” “ ” key to move the cursor, press “>” to set the password. If the password is correct, then press “Enter” to enter into the General Parameter menu.



- 3) If the password is incorrect, the LCD will display:

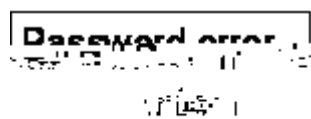

correct, press "Enter" key to enter into Step 2.

Start

and special parameter compose the basic factor of the elevator
to be "user class" and "factory class" according to the different requirements

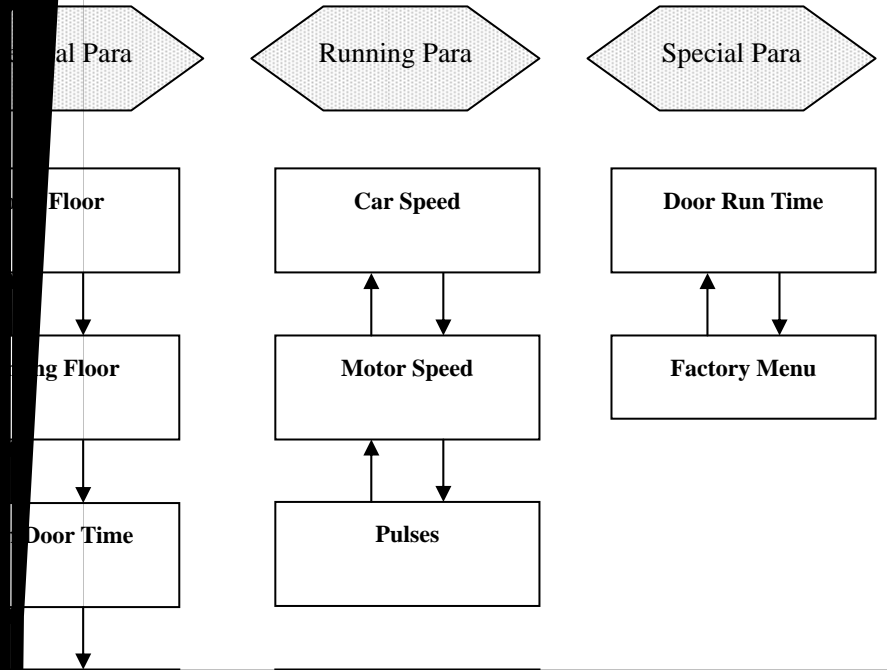

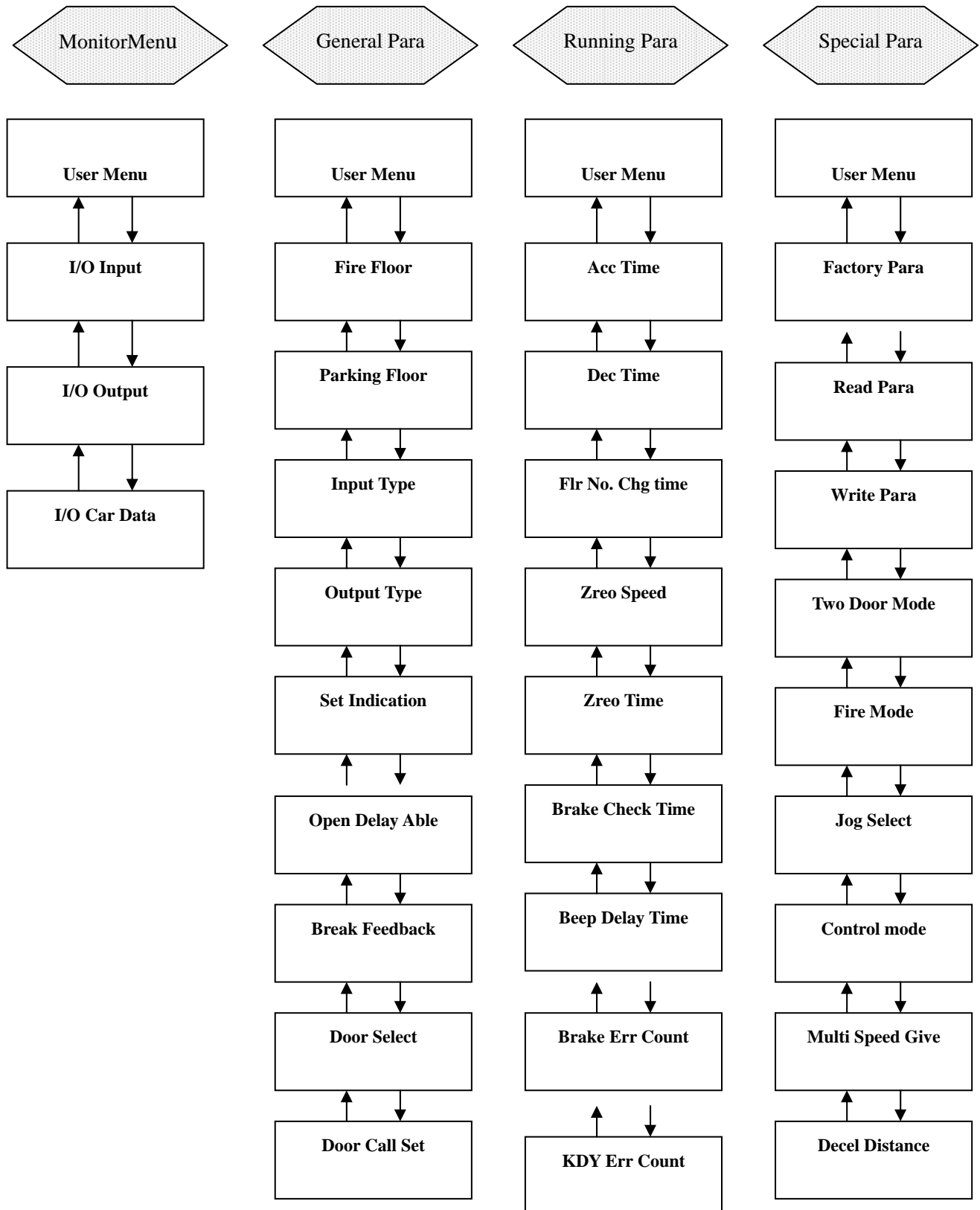

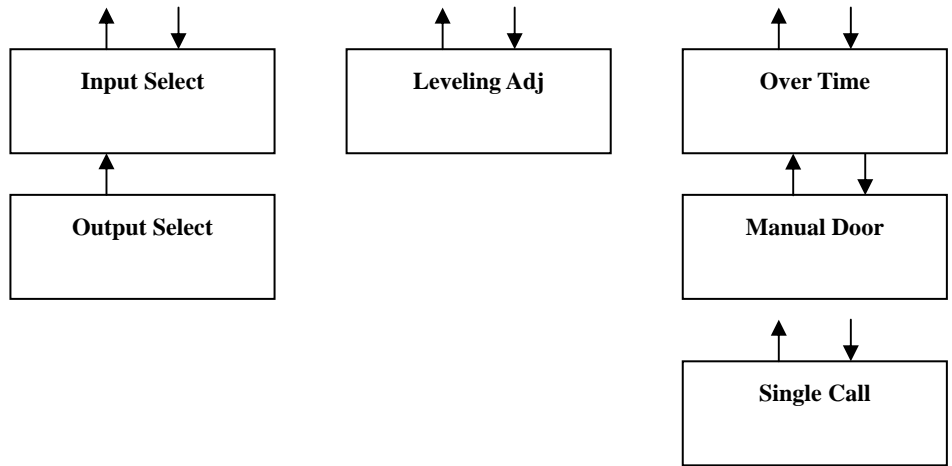

(2) Figure 3.3.3(b) Factory Menu

3.3.4 Parameter instruction

(1) **Monitor Menu:** Except call input, door open/close instruction could be entered, other parameters are only for read:

User Menu			
No	Menu	Note	Refer to
1	Call Input	It displays car call , landing call and inter selection	
2	Hoistway Data	It displays top and bottom limit and terminal position	
3	Floor Data	Leveling position and stop or not	
4	Speed Feedback	Motor speed (rpm) and elevator speed (m/s)	
5	Run Report	Accumulated running time	
6	Fault Report	The last 10 fault records	
7	Encoder Apprais	Valuate encoder interference and quality of pulse	
8	Input Apprais	Display the input interference and the inner state before the lastest 10 times stops	
9	Software No	Software version	
Factory Menu			
10	I/O Input	Input port state	
11	I/O Output	Output port state	
12	I/O Car Data	COP input and output state	

(2) **General parameter:**

User Menu			

17	Show Select	0	0~3	Set hall display code 0 7 segment 1 BCD code 2 Grey code 3 Point to Point 4 Ba
----	-------------	---	-----	---

(3)Running parameter:

User Menu				
No.	Menu	Default	Range	Note
1	Car Speed			

7	Jog Select	0*	0/1	0 No jog ourput 1 Jog output
8	Control Mode	SHS*	WVF/SHS	WVF: VVVF control SHS AC-2 speed control
9	Multi Speed Give	0*	0~1m/s	Set speed (corresponding to inverter speed given).
10	Decel Distance	0*	0~10m	Deceleration distance
11	Over Time	45*	0~999s	Limit running time for one time
12	Manual Door	No*	Yes/No	No: Automatic door ,Yes Manual door
13	Single Call	No*	Yes/No	No: Full collective selective, Yes Single collective selective
14	Function Select	OFF	ON/OFF	For optional function

Note: * parameter is default parameter.

3.3.5 Save parameter

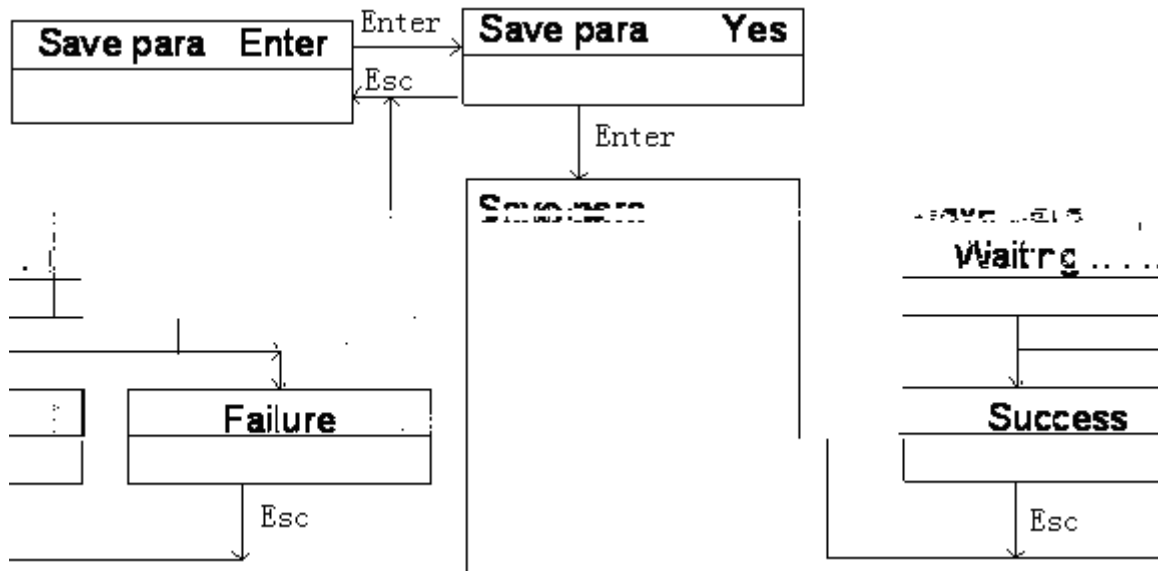

After entering into the save parameter menu, press “Yes”, then press enter key, system automatically save the modified parameters. If saving parameter is successful, it will display “Success”, If it is failed, it will display “Falure” , when saving parameters is failure, please contact with the factory .

Note: Modified parameters are valid at once, but they will be lost if the parameters haven’t been saved after power off.

3.3.6 Set password

Set and modify parameter, and save it.

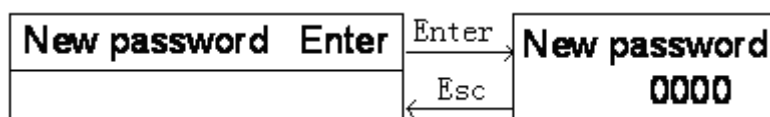

Hoistway Data Enter

2) Strike "Enter" key again to enter

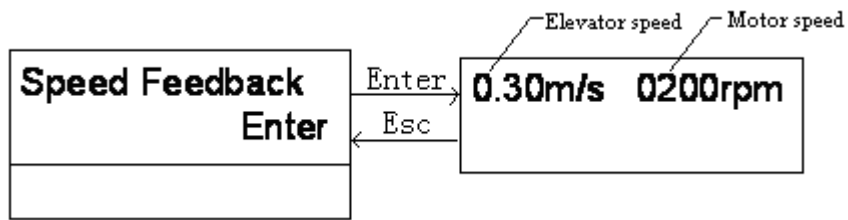

(5) Running record

It is accumulated time and times.

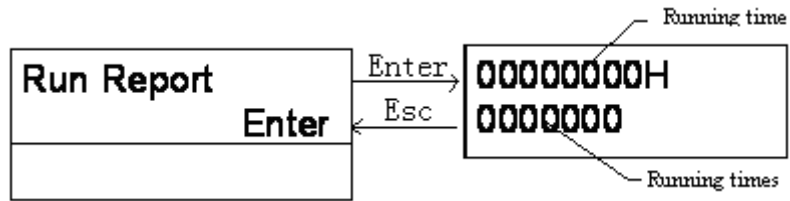

(6) Fault record

It records type and time of the latest 10 faults.

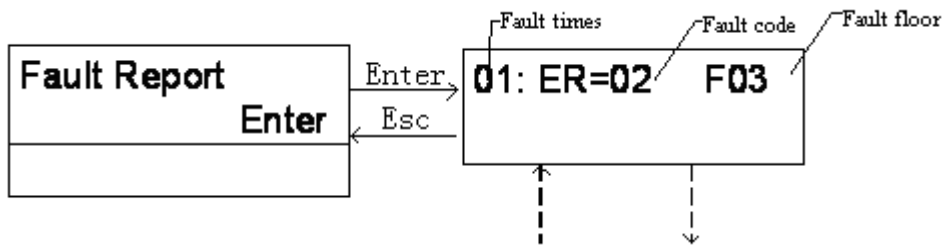

Ø Fault record is saved in memory () in 8 (e of) 9 (e.) 4 JT*20 (Them) 6 t l fved its. lof (ecor) 7.7 (e)-1.4 (TJ) 10 rank No () in. 1; Tq35 Tf-44.6 -12.3333
6) Fa7lt

- ∅ The stick map indicates the interference degree: " " represent logic level of I/O port is "0", corresponding indicator light off; " " represents logic level of I/O port is "1", corresponding indicator light on;
 - ∅ Stick represents logic level: High "1" Low "0";
 - ∅ The more closer the number of 1 is to the number of 0, the more intense the interference is.
- Note: The logic level has nothing to do with input port level setting.

(9) Software No.

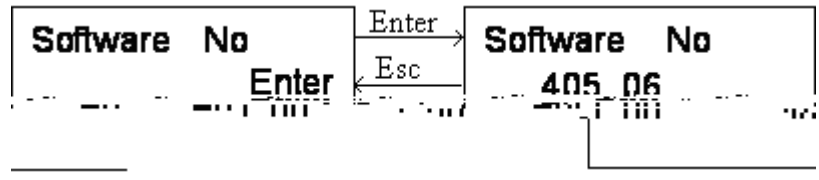

It is software version.

(10) Input signal (Point to Point display)

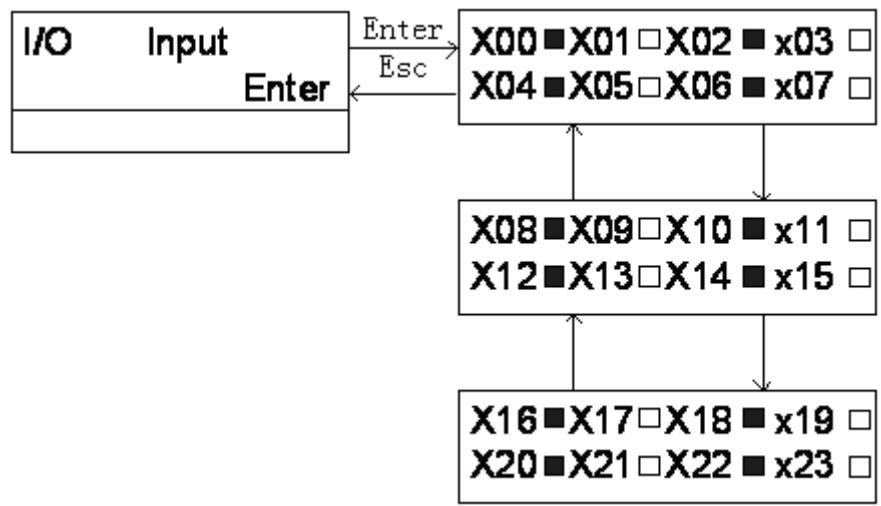

- ∅ input 1, light on
- ∅ input 0, light off

Note: The logic level has nothing to do with input port level setting.

(11) Output signal (Point to Point display)

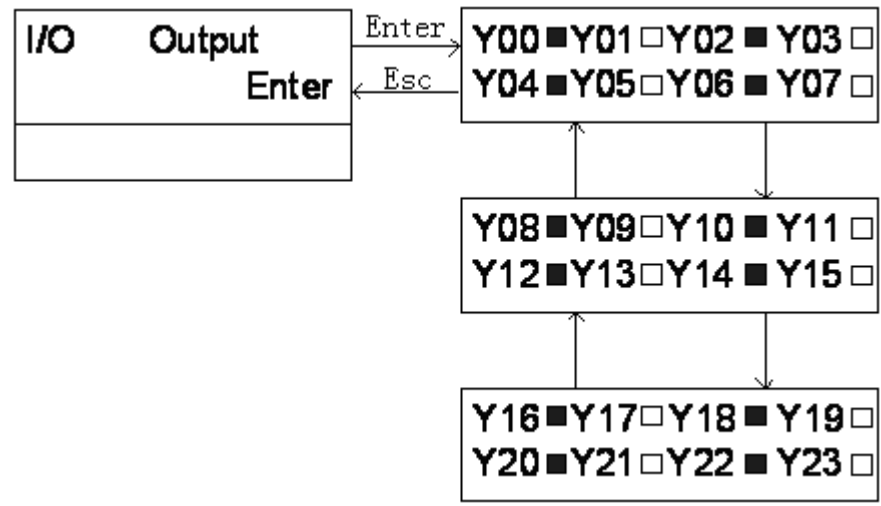

- Ø output 1, corresponding output relay close;
- Ø output , corresponding output relay open.

Note: The logic level has nothing to do with input port level setting.

(12) Car signal

Car signal includes door system input signal and COP input signal.

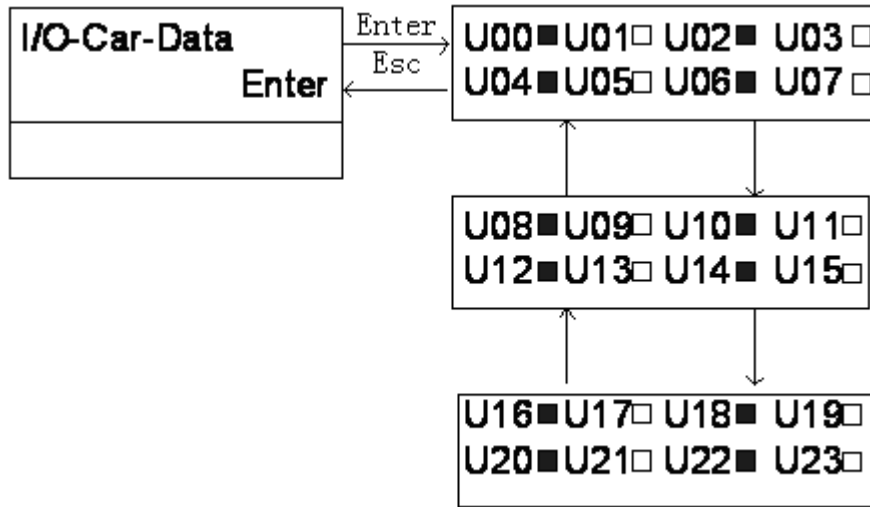

Table 3-5

No.	Definition	No.	Definition	No.	Definition
U00	Door close button 1	U07	Door open limit 1	U14	Light load switch
U01	Door open button 1	U08	Special switch	U15	Overload switch
U02	Door open button 2	U09	Door open holding switch	U16	No load (spare)
U03	Door close button 2	U10	Attendant switch	U17	Safety edge 2(For rear door)
U04	Door close limit 2	U11	Spare	U18	Safety edge 1
U05	Door open limit 2	U12	By pass switch	U19-U23	Spare
U06	Door close limit 1	U13	Full load switch		

- Ø input 1, input signal is valid
- Ø input 0, input signal is invalid

Note: The logic level “0” and “1” are related to input port level setting.

3.4.2 General parameter operation

Before you set parameter, you must input correct password (user password / factory password).

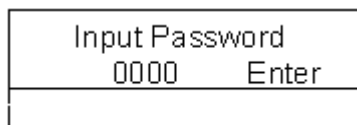

When you enter into input password menu, ‘ ’ select bit, ‘ ’ and ‘ ’ modify data, if password is right, it will display general parameter menu, otherwise, it will displays the following:

Password error Enter

Strike "Enter" to input password again, until password is right, strike "Enter" to enter into General Parameter interface:

General para Enter

Strick "Enter" to enter into general parameter setting:

- (1) Total floor No.

Set the total floor No.

Total Floor 12

When you strike 'enter' key, bottom right corner number twinkle, you can modify parameter, then you strike "Enter" confirm or "Esc" cancel. Total floors are equal to shelter board in hoistway.

- (2) Homing floor

Elevator reture to homing floor, if there isn't any car call or landing call.

Homing Floor 1

- (3) Door open holding time

It is elevator open door holding time in automation state. Door open time is adjusted by the reason of stop. If there is either car call or landing call, it is this time; if there are both car call and landing call, it is this time plus 2s.

Open Door Time 000s

- (4) Door open delay time

The door open time may be prolonged by striking open door delay button if this function is released. Unit: second.

Open Delay Time 000s

(5) Homing time

Elevator automatically returns to homing floor. Note: If the value is zero, elevator doesn't return to homing floor.

Homing Time 000s

(6) Fire floor

Note: Output relay (Inverter release) Y6 is ON for Fuji inverter.

(10) Floor indication

Indication character may be letter or figure.

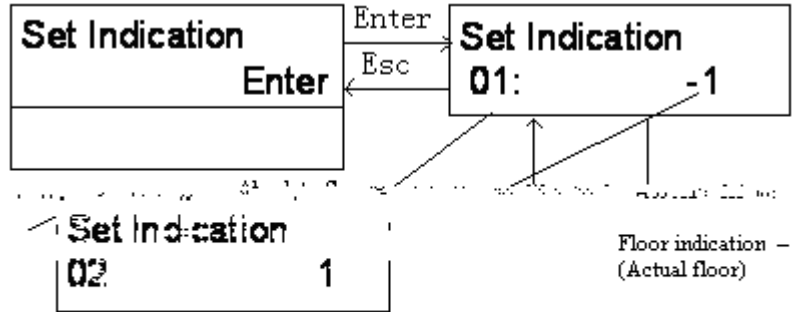

(11) Door open delay release

It is used to set door open delay valid/ invalid. (Optional)

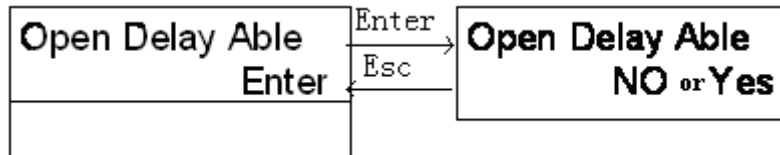

(12) Brake feedback detect release

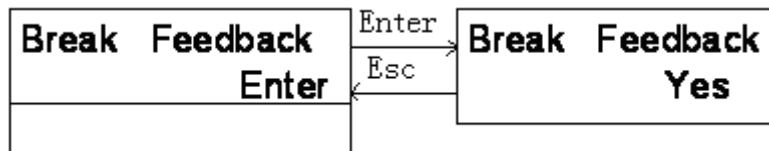

Yes System detects brake feedback

No: System doesn't detect brake feedback.

We suggest that detect switch be fixed on traction motor and feedback signal input into the system. Feedback detection function is released.

(13) Two door mode (it is valid when two door mode >0)

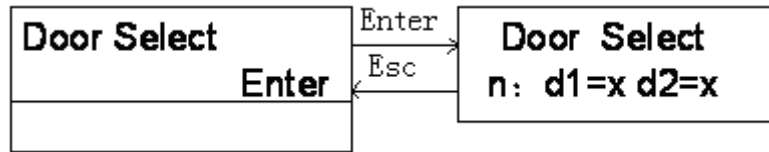

n Floor No. It could be changed by “ , ” key.

d1 Front door. Select it by “>” key.

d2 Rear door. Select it by “>” key.

x=Y: this door act

x=N: this door doesn’t act.

For example: two door elevator, on 6th floor, only front door act; on 7th floor, both front door and back door act.

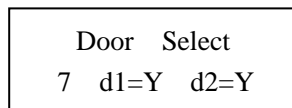
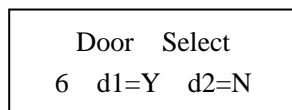

(14) Two door call distribution (It is valid when two door mode>1)

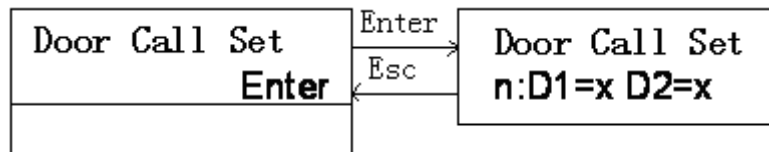

n Floor No. It could be changed by “ , ” key.

d1 Front door landing call. Select it by “>” key.

d2 Rear door landing call. Select it by “>” key.

x=Y: this door distributes its landing call

x=N: this door doesn’t distribute its landing call

It could be changed by “ , ” key.

For example: Two door elevator is total of 6 floors, on the 4th floor, there are two landing call boxes separately at the front door and rear door, on other floors, there is only one call box.

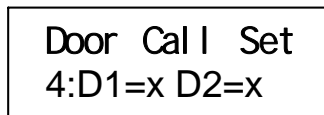

Front door landing call of 1st-6th floor is corresponding to landing call of 1st-6th floor, rear door down call of 4th floor is corresponding to up call of 6th floor , rear door down call of 4th floor is corresponding to down call of 7-6th floor.

(15) Multi-functional input set

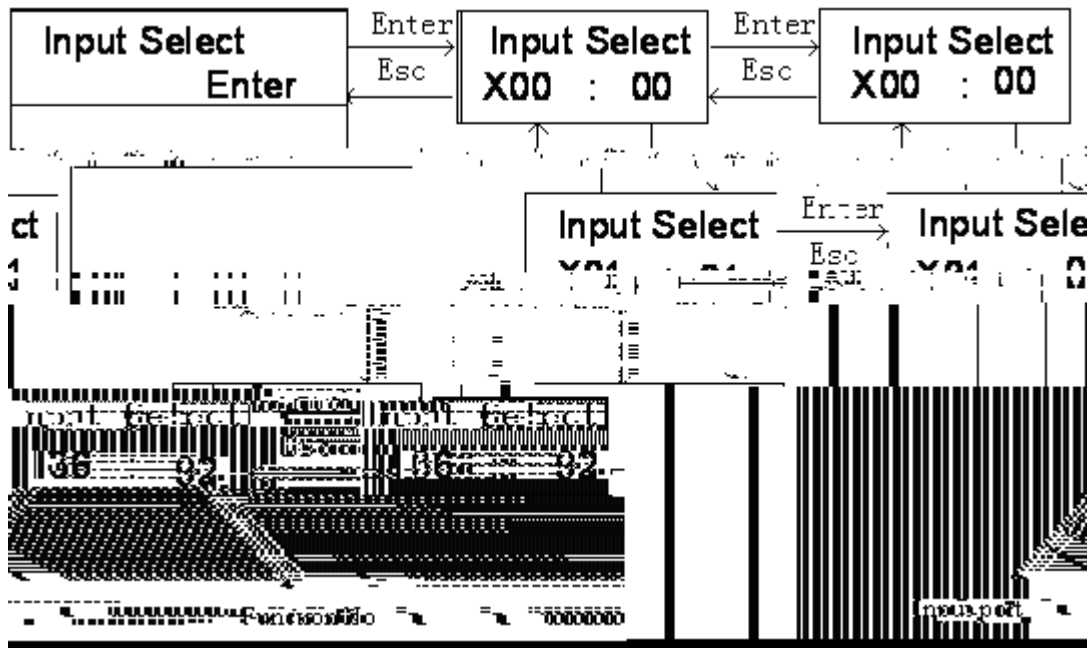

Multi-functional input function refers to chapter 2 I/O definition.

under “multi-function setting” if you want to set one function whose input points have been in existence the system will display all input points responding to this function. For example, provided, X1(input port) has been set “X1”(Function No.), after X0 being set “X1” and press “Enter” the system will display : X1 be set “X1”, so before X0 is sent “X1”The Com , X1 should be sent as other function No. or “99” (invalid).

(16) Multi-functional output set

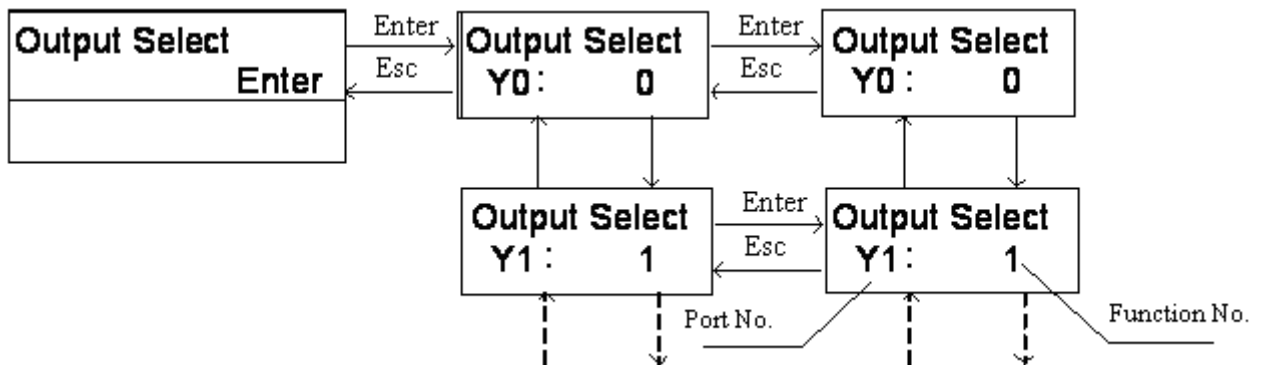

Multi-functional output function refers to I/O definition.

Please note whether the port COM is suitable to the multi-functional output setting .

(17) Display output code type

The default output of L5~L13 terminals is 7-segment code. It could be set BCD code , Grey code, etc.

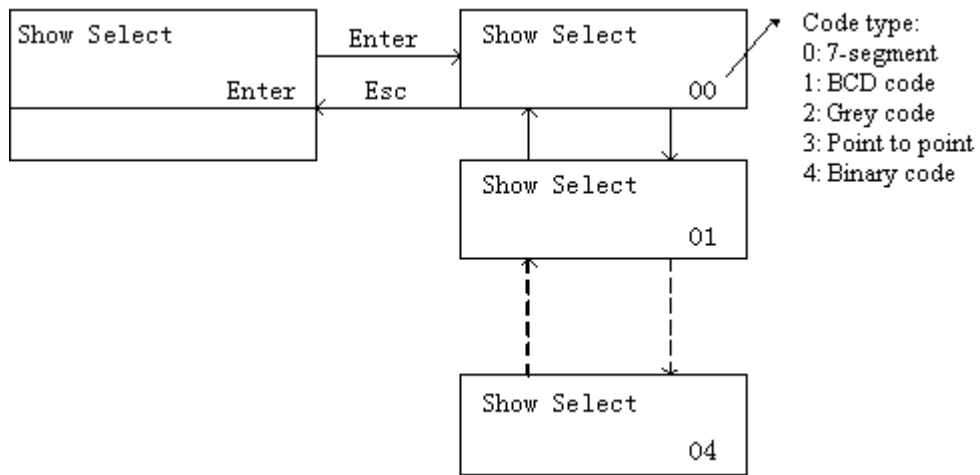

When output code type is set "1, 2, 3, 4"

Code	Terminal No.								
	Y18	Y19	Y20	Y21	Y22	Y23	Y24	Y25	Y26
1 2 4	Bit0	Bit1	Bit2	Bit3	Bit4	Bit5	Bit6	Inspection	"-"
3	1st floor	2nd floor	3rd floor	4th floor	5th floor	6th floor	7th floor	8th floor	"-"

3.4.3 Running parameter operation

It is used to set running parameters.

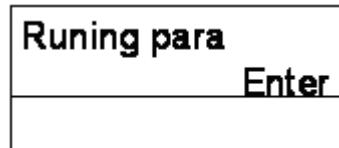

Strike "Enter" key to set parameters:

(1) Elevator rated speed

- Ø It is elevator rising speed under rated motor speed;
- Ø It could be set by nameplate of traction machine;
- Ø It also could be calculated by motor rated speed, traction ratio, sheave diameter.

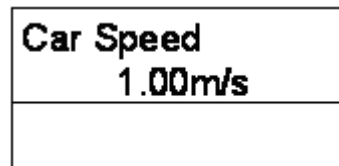

(2) Motor rated speed

It is set by nameplate.

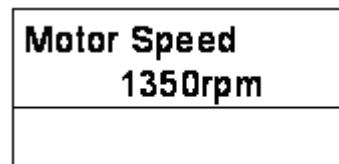

(3) Number of encoder pulse

- Ø The number of encoder pulse is input pulse to mainboard per revolve. When encoder is directly connected to the mainboard, it should be equal to the number of encoder pulse; otherwise it should be divided by frequency division ratio. (The max. frequency is 16kHz, if it is larger than 16kHz, it should be divided.)

Pulses 0600

Elevator rated speed, motor rated speed and number of encoder pulse are three important factors which determine if the elevator could run normally. If one of them is changed, hoistway learn must be performed before system normally runs.

Note: It is forbidden to change the parameters above to regulate the elevator speed.

(4) Ahead time for brake release

Passenger will feel more comfortable by adjusting it, system may adapt to all kinds of responding time traction motors.

Brake On Time 50ms

(5) Braking time

When System brakes, it outputs block torque by adjusting braking time. It realizes braking at zero speed.

Brake Off Time 50ms

(6) Acceleration time

Under AC-2 speed control mode, adjusting it could change elevator start time so as to adjust start comfort.

Acc On Time 1500ms

(7) Deceleration time

Under AC-2 speed control mode, adjusting it could change elevator stop time so as to adjust stop comfort and leveling accuracy.

Dec On Time 1500ms

(8) Floor No. Change delay

AC-2 speed: Delay time from receipt of the speed change signal to floor No. change, floor account change; Multi-speed: Delay time from reaching the middle of one floor to floor No. change, floor account change.

Fir No. Chg Delay 0000ms

(9) Zero speed

(14) KDY detection times

KDY detection errors accounts to this number, and fault still exists, it should be power off to restore.

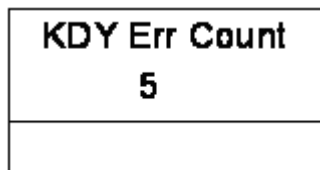

(15) Leveling adjustment

When elevator stops at different position for up/ down running on the same floor, adjusting it (up-running: higher and down-running: lower, reduce it, v.v.) Adjustment value is half of the leveling deflection. (Default: 50mm)

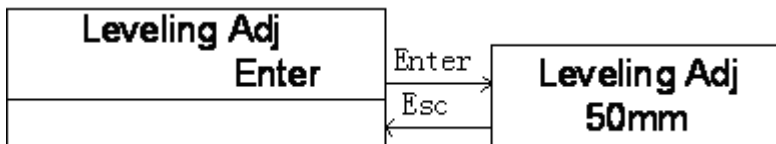

3.4.4 Special parameter operation

It is used to set special parameters.

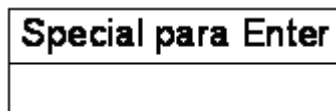

(1) Door open/close relay holding time

It is holding time of door open/close instruction. When there is no door open/close limit, door open/close time is determined by this parameter., When there are door open/close limi, it is a second longer than actual door open/close time.

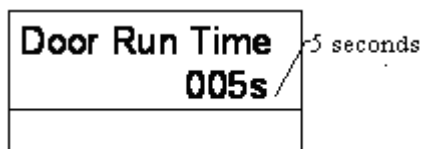

(2) Restore default



Yes: restore default When system parameters are disordered, you can restore default to debug again.

(3) Read parameter

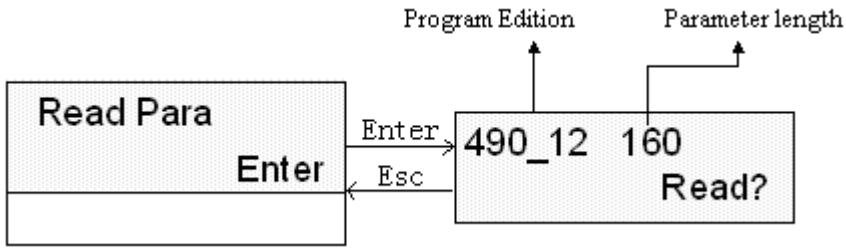

Read the parameters from mainboard to manual operation device and save them, manual operation device could save the latest read parameters, Success or not will be displayed as follows:

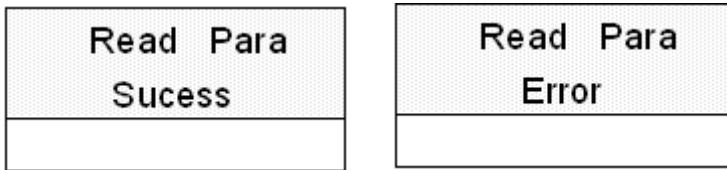

(4) Write parameter

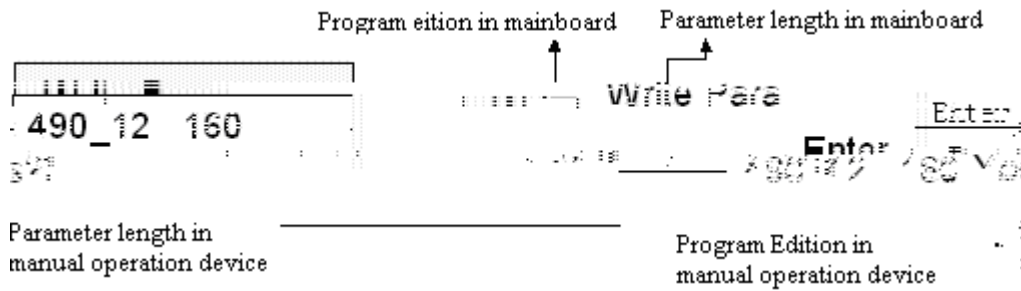

Write parameters from manual operation device to mainboard, but they are not saved, if you want to save them, please use save parameter menu. Success or not will be displayed as follows:

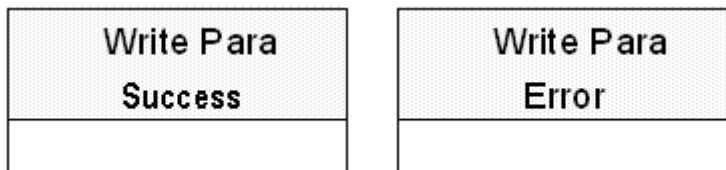

- Note: 1) When program edition of mainboard and manual operation device are different, the written parameters should be tested.
 2) Hoistway self-learning should be performed again after parameters being written in.
 3) If writing parameter is failed, turn off power of mainboard then turn on, restore previous parameters.

(5) Two door mode

When there are two doors at the same floor, door open/close mode can be sent by user's requirement.

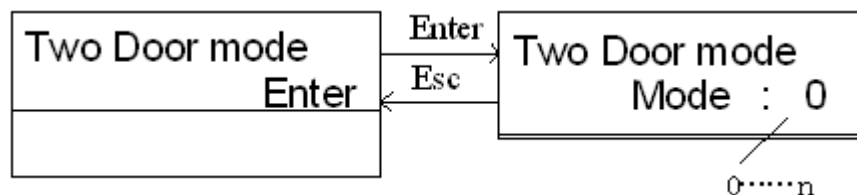

- ∅ n=0 Single door mode;
- ∅ n=1 Two door mode 1 only one door acts on one floor.
For example:
3floors/3stops elevator, only front door acts on 1st and 3rd floor, only rear door acts on 2nd floor;
- ∅ n=2 Two door mode 2 two doors both act on one or more floors, it works as following logic:
 - On two door floor, only one door could be operated at same time, and only after the door interlocks again, the other door could be operated;
 - On two door floor, when one door close, if another door's close limit is invalid, two doors close;
 - In inspection state, whatever it is two door or not, two door both can open, but they can't open at same time;
- ∅ n=3 4 Two door mode 3,4 , two doors can both act on some floors (at least one floor has two doors) it works as following logic:
 - On two door floor, two doors open/close at same time anytime except in inspection state.
- ∅ n=5 Two door mode 5, two doors can both act on some floors (at least one floor has two doors) it works as following logic:
 - On two door floor, elevator stops by car call, two doors open, otherwise only the door at landing call side will open, door open/close button and landing call only correspond to that door.
- ∅ Under two door mode 2~5, front door and rear door correspond to different landing call and car call, for N floor elevator, landing call (car call) input "1 ~ N" correspond to front door of 1 ~ N floor, landing call(car call) input "N+1 ~ N+N" correspond to rear door of 1 ~ N floor.

(6) Fire mode

When fire mode is 1, elevator only returns to fire floor when fire emergency.

If fire mode is 0, you should consider whether there are enough firefighting devices, otherwise it will incur accident.



(7) Jog output selection

When Drive is set "Yes", there is jog output. If "No", there is no jog output.

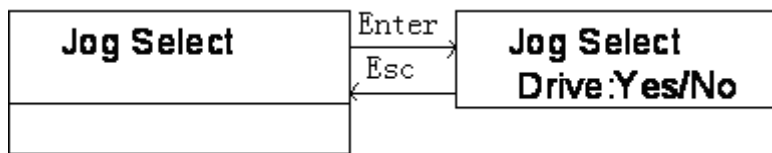

(8) Control mode selection

When elevator control mode is multi-speed, it should be set "WVF"; when control mode is AC-2 speed, it should be set "SHS", default is SHS.

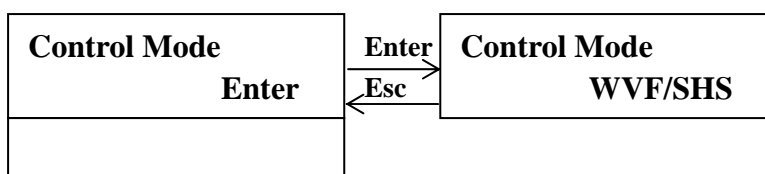

(9) Multi-speed set

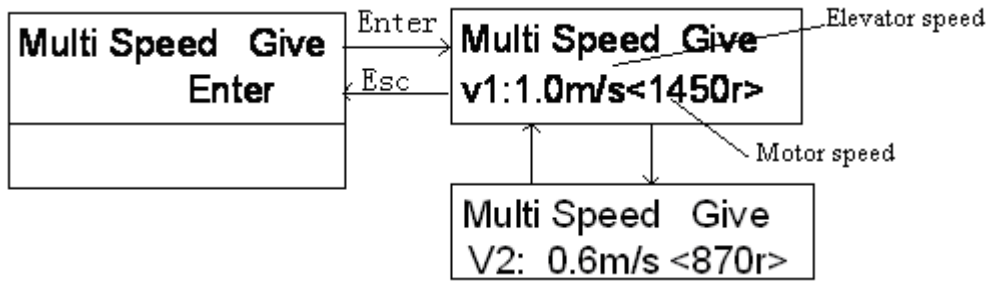

When multi-speed given is released, it is necessary to set multi-speed value and speed change distance.

A table of multi-speed value and speed change distance corresponding to different elevator speed is as follows (only for reference)

Table 3-10

Parameter	Value	Elevator speed	
		Speed V	Distance S
V1/S1	1.0m/s	1m/s	1.3m
V2/S2	0	0	0

Note: 1) V1~V2: From high speed to low speed (V1 is set by elevator rated speed);

2) S1~S2: Speed change distance corresponding to V1~V2, S1~S2 will influence the leveling accuracy;

For example, when elevator speed is 1.0m/s, set max. speed V1 "1m/s", set V2 "0"; Control system select different speed according to different target distance to reach max. efficiency and comfort.

3) Inspection, crawl and self-learning speed can be set by corresponding parameter in inverter;

4) Once the speed value is set, LCD indicator will display the corresponding motor speed, multi-speed value parameter of inverter should be set by this value. (Unit: rpm)

V1~V2 are for system inner calculation, only changing the parameter can't lower the elevator actual speed.

Multi-speed instruction output logic

Multi-speed instruction consists of Y13, Y4, Y15 three outputs.

Table 3-11

Speed	port	Y15 J6-12	Y14 J6-11	Y13 J6-10
Inspection(no jog)		0	1	0

Self-learning	0	0	1
Crawl	0	1	1
Medium speed 2 V2	1	1	0
High speed V1	1	1	1

Note: Please follow the table above to set multi-speed value of inverter.

(10) Deceleration distance

Deceleration distance is the distance from speed change position to leveling position.

In multi-speed mode, in order to avoid braking at non-zero speed and long crawling time, deceleration distance is different for different speed;

- Ø It should be adjusted by test.
- Ø Table 3-10 is only for reference.

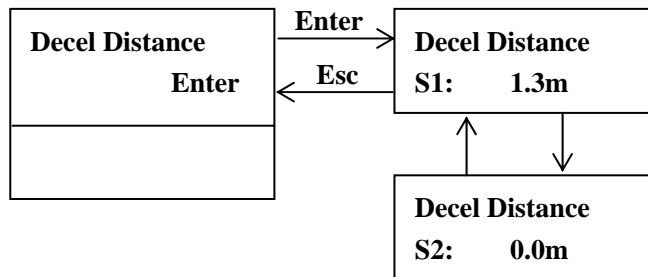

(11) Running overtime set

- Ø To avoid damage to system caused by rope slide or car box block, the time from start to stop should be limited . This parameter is the time limit;
- Ø If running time of one time exceeds the value, system will enter into protection state at once, and only after power is turned on again, system can get out from protection state;
- Ø User should set the parameter according to elevator speed and building height. Default is 45s.

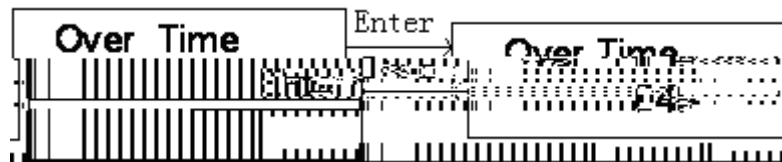

(12) Manual door selection

Default is automatic door, when elevator door is manual door, set the parameter "Yes".



(13) Single collective selective set

Default is full collective selective, when it is set “Yes”, system is of single collective selective.

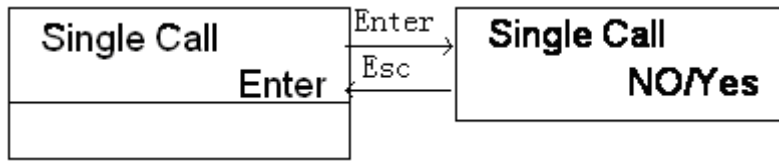

(14) Special function selection

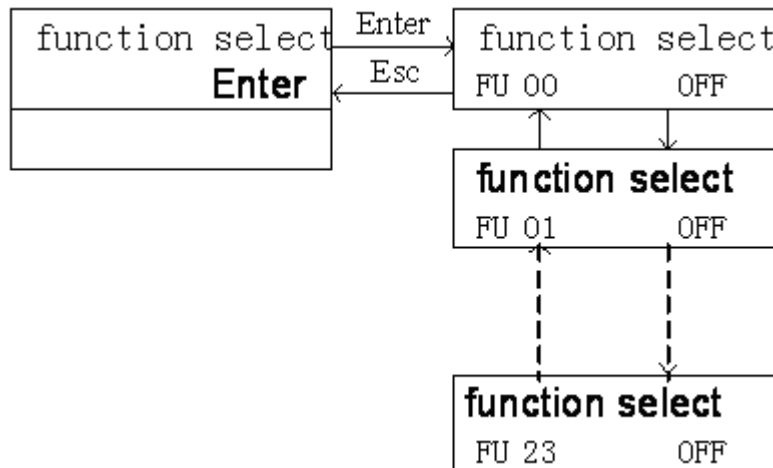

To satisfy clients’ special requirement, there are some special functions in the microprocessor system, they are optional.

Table 3-12 Special function

Function No.	Instruction
FU00	After elevator stops, system regards current floor as basic floor, if there is no landing car and car call on the floors above the basic floor in previous running direction, all registered car call will be canceled.
FU01	For inner test
FU02	When elevator runs to crawl section, inverter speed is given 0 after encountering double leveling zone switch; otherwise inverter speed is given 0 after encountering single leveling zone switch, it is default.
FU03~FU23	Spare

Appendix 1 Figure of time-speed

VVVF driving: adopt multi-speed control mode

Multi-speed output instruction consists of Y8, Y9, Y10 three outputs.

Speed	Y10 J5_14		Y9 J5_12		Y8 J5_11	
	Port		Port		Port	
Inspection (jog)		0		1		0
Crawling speed		0		1		1

Normal speed	1	1	
--------------	---	---	--

Inspection (no jog)

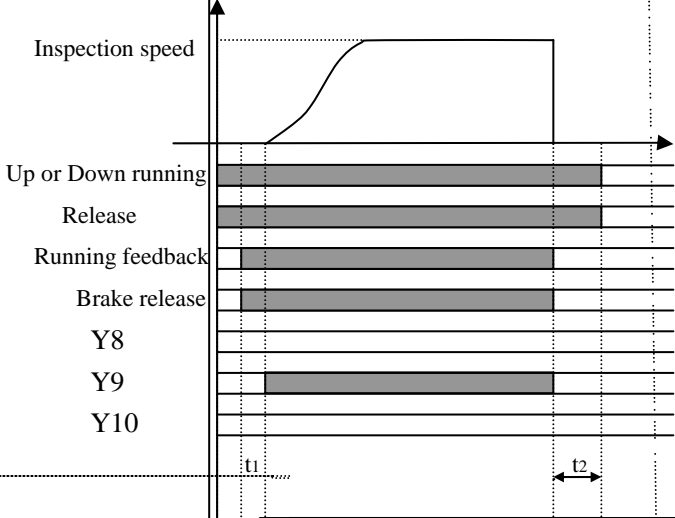

t1: Ahead time for brake release t2: Release hold time after stop(it can't be set)

Inspection (jog, ex. YASKAWA inverter)
 If Drive mode is Yes, there is jog output, inspection speed is controlled by Y5.

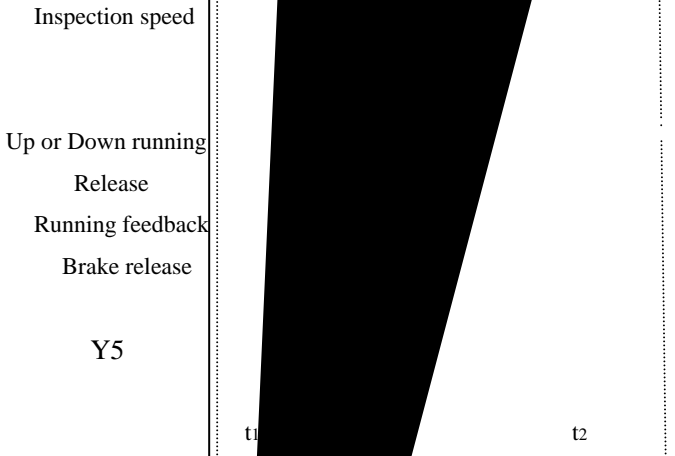

t1: Ahead time for brake release t2: Release hold time after stop(it can't be set)

Normal running

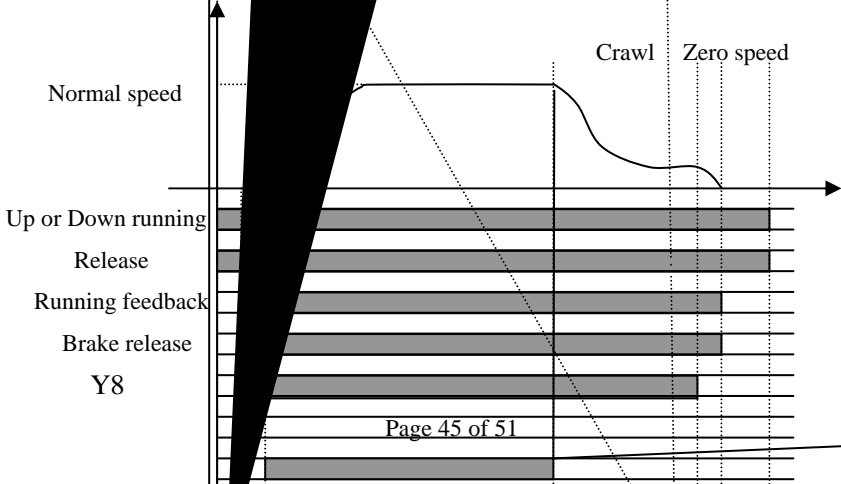

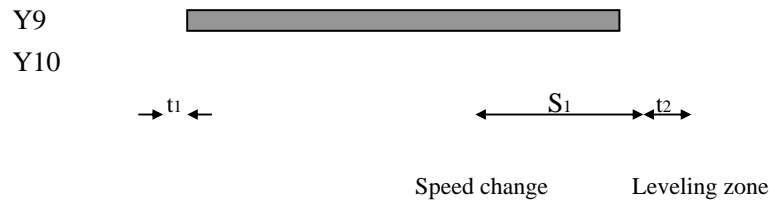

S1 is speed change distance under normal running.

Note: If the Drive is “Yes”, Y5 outputs signal when crawl changes to zero speed given, Y5 output is switch of deceleration time. (For example, when YASKAWA inverter changes from crawl to zero speed, it switches the deceleration time to adjust leveling.)

AC-2 speed control, time-speed figure for normal running

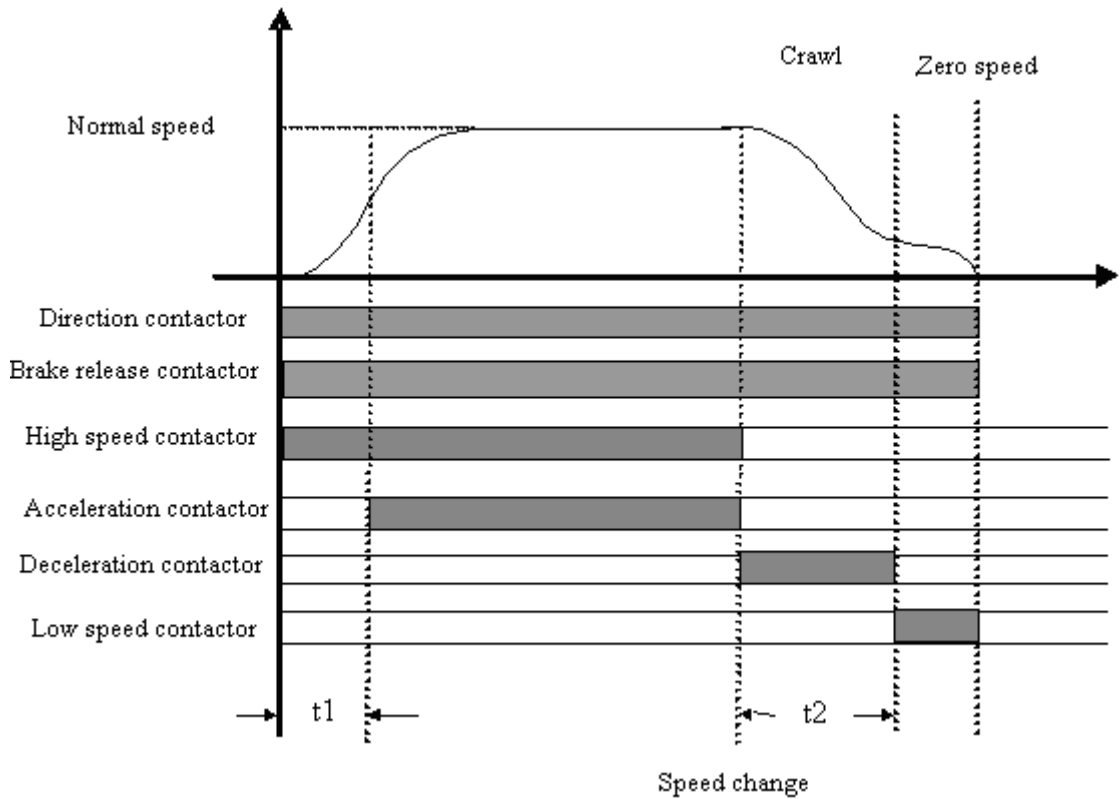

t1: Acceleration contactor switch time (acceleration time), t2: Deceleration contactor act time (deceleration time), the two parameters can be set in running parameter menu “Acc On Time”(t1) and “Dec On Time” (t2) .

Appendix 2 YASKAWA G7A Inverter Experienced Parameter Setting Table

(1) First set parameter A1-02=3(2), secondly “initialize” parameter A1-03=2220(3), then set parameters as follows: (only for reference)

Parameter	Name	Value	Remark
A1-00	Language selection	0	English
A1-01	Parameter saving grade	2	ADVANCED
A1-02	Control mode selection	3	PG vector control
B1-01	Frequency instruction selection	0	Control circuit terminal (Multi-section input)

B1-02	Running instruction selection	1	Control circuit terminal
B1-03	Stop method selection	1	Free slide deceleration
B1-04	Anti-reverse selection	0	Reversible
B2-01	Zero speed logic level	0.1	At the end of deceleration, set DC brake starting frequency by HZ unit, If B2-01<E1-09, DC brake will start from E1-09. (In PG control, B2-01control zero speed)
B2-03	DC braking time at starting	0	DC braking is invalid at starting
B2-04	DC braking time at stop	1	Unit : S
C1-01	Acceleration 1	2.5	Set acceleration time from 0% to 100% of the max. frequency output
C1-02	Deceleration	2.5	Set deceleration time from 100% to 0% of the max. frequency output
C1-03	Acceleration 2	2.5	Acceleration time when Multi-functional input "Acceleration/deceleration time selection 1" is ON
C1-04	Deceleration 2	8.0	Deceleration time when Multi-functional input "Acceleration/deceleration time selection 1" is ON
C2-01	Acceleration begin characteristic time	0.7	
C2-02	Acceleration end characteristic time	0.5	
C2-03	Deceleration begin characteristic time	0.7	
C2-04	Deceleration end characteristic time	0.7	
C5-01	Speed control proportion gain	10	Set speed control circuit proportion gain
C5-02	Speed control time 1	0.35	Set integral time of speed control circuit by unit " s"
D1-02	Frequency instruction 2	10	Frequency instruction when multi-functional input "Multi-speed instruction 1" is ON
D1-03	Frequency instruction 3	10	Frequency instruction when multi-functional input "Multi-speed instruction 2" is ON
D1-04	Frequency instruction 4	3	Frequency instruction when multi-functional input "Multi-speed instruction 1 and 2" is ON
D1-08	Frequency instruction 8	48	Frequency instruction when multi-functional input "Multi-speed instruction 1 , 2 and 3" is ON
D1-17	Jog frequency instruction		Frequency instruction when multi-functional input "jog frequency selection" is ON, "FJOG instruction" is ON
E1-01	Inverter input voltage setting	380	
E1-02	Motor selection	0	Standard motor
E1-04	Max. frequency output	50	
E1-05	Max. voltage	380	
E1-06	Base frequency (FA)	50	
E1-09	Min. frequency output (FMIN)	0	
E2-01	Motor rated current	*	Set it by unit " A" , it is set automatically after self-learning.
E2-02	Motor rated rotation difference	*	Set it by unit " HZ" , it is set automatically after self-learning.
E2-03	Motor empty load current	*	Set it by unit " A" , it is set automatically after self-learning.
E2-04	Motor poles	*	Set poles No., it is set automatically after self-learning.

E2-11	Motor rated capacity	*	Set it by unit " 0.01KW", it is set automatically after self-learning.
F1-01	PG constant	*	By encoder
F1-02	PG open action (PGO)	1	Free slide stop
F1-03	Overspeed action (OS)	0	Deceleration stop(By C1-02 deceleration time)
F1-04	Speed over-deflection action (DEV)	0	Deceleration stop(By C1-02 deceleration time)
F1-06	PG ourput frequency division ratio	1	Set pulse ouput division ratio $= (1+n)/m$, n=0,1 m=1 32
F1-08	Overspeed value (OS)	105	When ouput frequency is above F1-08 value (Max. output frequency is 100 , unit is) and keeps for F1-09, it detects the overspeed.
F1-10	Speed over-deflection value (DEV)	30	When speed deflection is above the F1-10 value (Max. output frequency is 100 , unit is) and keeps for F1-11, it detects speed over-deflection. Speed deflection is the difference between motor actual speed and speed instruction.
F1-11	Speed over-deflection detection time (DEV)	1	
H1-03	Terminal S5 function selection	3	Multi-functional input 3
H1-04	Terminal S6 function selection	4	Multi-functional input 4
H1-05	Terminal S7 function selection	5	Multi-functional input 5
H1-06	Terminal S8 function selection	F	Multi-functional input 6
H1-07	Terminal S9 function selection	F	Multi-functional input 7
H1-08	Terminal S10 function selection	7	Multi-functional input 8
H1-09	Terminal S11 function selection	F	Multi-functional input 9
H1-10	Terminal S12 function selection	9	Multi-functional input 10
H2-01	Terminal M1 M2 function selection	37	Multi-functional output
L3-04	Drop speed function of decelerationselection	0	Invalid
L5-01	Reset times	5	
L8-05	Input phase lost protection	1	valid
L8-07	Output phase lost protection	1	vallid
O1-01	Monitor selection	5	Display monitor items

Appendix 3: System Troubleshooting

Code	Note	Process
Er0	Parameters are not initialized or parameter zone has fault	Saving parameter operation can solve the problem, if can't, contact with factory
Er1		
Er2	Door inter-lock fault Door inter-lock circuit open when elevator running	Check door interlock circuit and door cam

Er3	Inverter fault		Check inverter
Er4	Direction contactor fault, direction given is different with the feedback of direction contactor		Check the direction contactor connection. Direction feedback should be connected to NO contacts of direction contactor.
Er5	Brake release fault, system doesn't receive the feedback from brake contactor or brake detection switch		Check brake detection switch and connection , if there is no such switch, Brake Feedback should be set "OFF".
Er6	During running, leveling zone signal is valid all the time.		Check leveling zone signal and inductive switch
Er7	During runnin, input pulse No. to control unit is too small		Check pulse input circuit od main control unit and encoser connection.
Er8			Please contact with factory
Er9	KDY/KKC fault, KDY/KKC output instruction is different with the feedback		Check KDY/KKC output , feedback circuit and KDY/KKC contactor
Er10	Emergency stop circuit open		Check emergency stop circuit
Er11	Elevator doesn't detect leveling zone signal		Check leveling zone signal circuit and inductive switch
Er12	Over top limit		Check encoder and related circuit.
Er13	Over bottom limit		Check encoder and related circuit.
Er14	VVVF	Floor counter fault. When this fault happens, elevator will run slowly to the bottom floor and adjust the position.	Check encoder and related circuit check leveling zone circuit. Typical fault: leveling zone signal tingle or rope slide
	AC-2	KMC feedback is inconsistent	Check KMC output , feedback circuit and KMC contactor
Er15	AC-2: KPC feedback is inconsistent		Check KPC output , feedback circuit and KPC contactor
Er16			
Er17	Main control unit output instruction, but it doesn't receive inverter running signal		Check inverter direction, relese signal and running signal output circuit, check rated parameters setting
Er18	Floor counter fault		Ffloor counter suddenly has fault, elevator will run slowly to the bottom floor and adjust the position.
Er19	Speed change distance is too long to level to the nearest floor.		According to V1 V4, set suitable speed change distance.
Er20	Termnial overspeed protection, speed feedback isn't lowered as the speed given		Check whether inverter parameters are correct, or the inverter is destroyed.
Er21	Running overtime		Check if rope slid or car block , check Over Time setting
Er22	Inspection signal input at high speed running		Check inspection switch and rated circuit.
Er23	One of two leveling zone signal is invalid		Check leveling zone signal circuit and inductive switch.
Er24	Speed change distance is too short		According to V1 V4, set suitable speed change distance.
Er25	Thermal relay protection, brake unit or motor overheating		
Er26	Door interlock fault: The state of door interlock contacts is inconsistent with the state of circuit.		Check door interlock contactor circuit, contacts state, related input ports on mainboard.
Er28	Terminal adhere protection		Check terminal signal input
U	Door open default, when door open limit is valid or it is door open time, door interlock doesn't open. It displays		Check door open output relay, door open limit, door interlock circuit or if door interlock is short-circuited.

	“ □ ”.	
N	Door close default, when door close limit is valid or it is door close time, door interlock doesn't close. If the fault happens, system will open the door, then close the door again; Repeat 5 times, if the interlock still doesn't close, system won't close door and display fault code. It displays “ □ ”.	Check door close output really , door close limit , door interlock circuit.

Appendix 4 Troubleshooting while Hoistway Learning

No.	code	note	process
1	LER=0	System running protection	Strike 'esc', check fault record
2	LER=1	Pulse input phase reverse	Exchange A phase and B phase
3	LER=2	Bottom terminal 1 input repeat	Bottom terminal 1 fixed in error or tingle
4			
5			
6			
7			

8			
9			
10	LER=9	Bottom terminal 1 lost	Arrive at top Terminal 1 before bottom terminal 1 or bottom terminal 1 lost
11	LER=10	Top terminal 1 input repeat	top terminal 1 fixed in error or tingle
12	LER=11	Top terminal 1 lost	Arrive at top limit before top terminal 1 or top terminal 1 lost
13	LER=12	No. of total floors error	Check total floor set and shelter board fix
14	LER=14	Two leveling zone switches are never overlaped	Shelter board can't shield two switches, or lost one switch
15	LER=15	Push 'esc' cancel it	Someone pushes 'esc' key
16	LER=17	Leveling zone 1 and 2 input at the same time	The wires of two switches are parallel connected
17	LER=18	Save data in error	Contact with us
18	LER=19	Arrival at top limit, two leveling zone signals input, top limit is fixed too low	move the top limit up and try again
19	LER=20	Bottom limit is fixed too high	move the bottom limit down and try again